

LPU-2428 & RST-4101 User Manual

Table of Contents

Introduction	iii
Warranty and Warranty Restrictions	iv
Chapter 1: Specifications and Options.....	1
Dimensions	1
Specifications	2
Chapter 2: Installation and Removal Procedures and Notes.....	3
Tools Needed.....	3
Installation Notes	3
Mounting Instructions	4
Electrical Installation	4
Software Installation.....	5
Removal Instructions	5
Chapter 3: Maintenance	5
General Care	5
Troubleshooting.....	6
Calibration	6-7
Repair and Returns.....	7
Chapter 4: Programming and Parameter Configuration	8
Software User Interface.....	8-9
Programming the LPU-2428.....	10
Basic Setup Menu	11-12
App. Setup Menu.....	13-31
4-20 Setup Menu	31-32
Calibration Menu	33-34
Advanced Menu	34-36
Utilities Menu.....	36-38
Totalization Menu.....	39
Chapter 5: Hazardous Location Drawing and Certification	40
Intrinsically Safe Wiring Diagram	40
Hazardous Location Wiring Diagram	41
CSA Certificate of Compliance	42-45

Introduction

Thank you for purchasing an LPU-2428 ultrasonic sensor and RST-4101 programming module from APG. We appreciate your business! Please take a few minutes to familiarize yourself with your LPU-2428, RST-4101, and this manual.

The LPU-2428 loop-powered ultrasonic sensor provides a low-power, non-contact level measurement solution rated for hazardous locations and suitable for harsh chemical environments.

The default Application setting for the LPU-2428 is Distance, which will work in a wide variety of settings. The LPU-2428 has several additional Application settings that can be configured to meet your needs.

Reading your label

Every APG instrument comes with a label that includes the instrument's model number, part number, serial number, and a wiring pinout table. Please ensure that the part number and pinout table on your label match your order. The following electrical ratings and approvals are also listed on the label. Please refer to the Certificate of Compliance at the back of this manual for further details.

Electrical ratings



Input: 12 to 28 Volts DC; Output: 4-20mA
Class I Division 1; Groups C, D T3
Class I, Zone 0, Group IIB
AEx ia IIB T3 (USA): Ta: -40°C to 60°C; IP65
Ex ia IIB T3 (Canada): Ta: -40°C to 60°C; IP65

$V_{max} U_i = 28VDC$, $I_{max} I_i = 130mA$, $P_{max} P_i = 0.91W$, $C_i = 0nF$, $L_i = 110\mu H$
Install in accordance with drawing 9002747 (page 42).



Input: 12 to 28 Volts DC; Output: 4-20mA
Class I Division 2; Groups C, D T6
Class I, Zone 2, Group IIB
AEx nA IIB T6: Ta: -40°C to 60°C; IP65
Ex nA IIB T6: Ta: -40°C to +60°C; IP65

Install in accordance with drawing 9002745 (page 43).

i IMPORTANT: Your LPU-2428 MUST be installed according to drawing 9002747 as indicated above to meet Intrinsically Safe approvals. Faulty installation will invalidate all safety approvals and ratings.

Warranty and Warranty Restrictions

This product is covered by APG's warranty to be free from defects in material and workmanship under normal use and service of the product for 24 months. For a full explanation of our Warranty, please visit <https://www.apgsensors.com/about-us/terms-conditions>. Contact Technical Support to receive a Return Material Authorization before shipping your product back.

Scan the QR code below to read the full explanation of our Warranty on your tablet or smartphone.



Chapter 1: Specifications and Options

- Dimensions

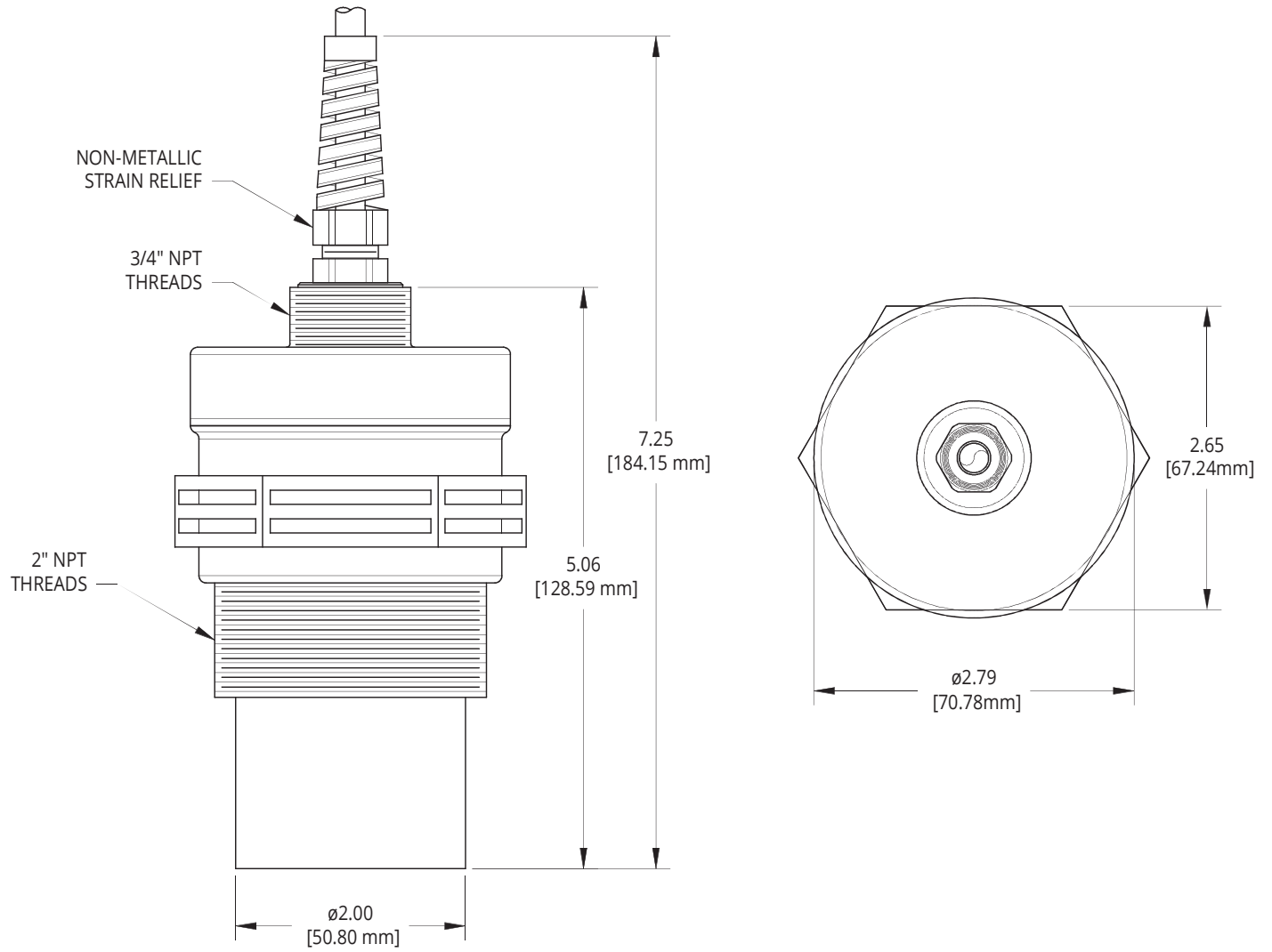

• Specifications

Performance

Operating Range	1 - 25 ft. (0.3 - 7.6 m) on liquids and hard, flat surfaces 1 - 10 ft. (0.3 - 3 m) on bulk solids
Analog Output (Sensor)	4-20 mA
Analog Output (Module)	USB
Beam Pattern	9° off axis
Frequency	69 kHz
Response Time	0.6 - 3 seconds (dependent on output range)
Sample Rate	3 seconds @ 4 mA 0.6 seconds @ 20 mA

Accuracy

Accuracy	±0.25% of detected range
Resolution	0.1 inch (2.54 mm)

Environmental

Operating Temperature	-40 to 60°C (-40 to 140°F)
Internal Temperature Compensation	Yes
Enclosure Protection	IP65
NEMA rating (Sensor)	4X

Electrical

Supply Voltage (at sensor)	12-28 VDC
Current Draw	22 mA max
Output Signal	3-30 mA max
Load Resistance	150Ω max @ 12 VDC 600Ω max @ 24 VDC
Cable Connection (Sensor)	2-wire cable included
Cable Connection (Module)	2-terminal Phoenix connector, USB

Materials of Construction

Transducer Housing	PVDF (Kynar®)
Upper Housing (Sensor)	PC/PBT
Housing (Module)	ABS PA-756

Chapter 2: Installation and Removal Procedures and Notes

- **Tools Needed**

Tools are not necessary for installing the LPU itself. If you are using a stand pipe to mount your LPU, you will probably need tools to install the stand pipe, but not for the LPU.

- **Installation Notes**

- Mount your LPU sensor so that it has a clear, perpendicular sound path to the surface being monitored. Your sensor should be mounted away from tank or vessel walls and inlets. See Figure 2.1.
- The sound path should be free from obstructions and as open as possible for the 9° off axis beam pattern.
- If you are using a stand pipe, please see our guide to stand pipes on our website: <http://www.apgsensors.com/about-us/blog/how-to-install-a-stand-pipe>.

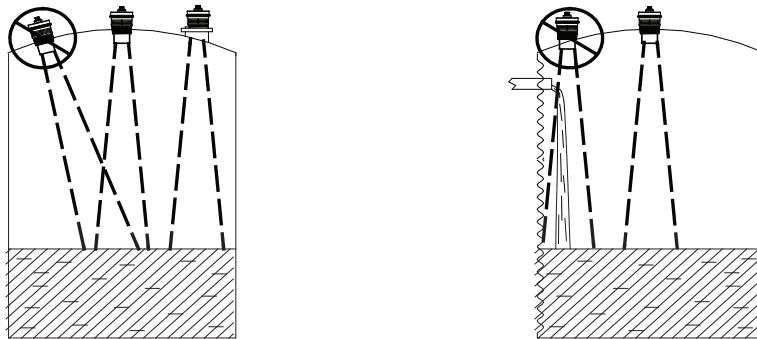



Figure 2.1

 **NOTE:** Do not mount the sensor where the beam will intersect objects such as fill streams, pipes, ladder rungs, wall seams, or corrugated tank walls.

• Mounting Instructions

Mounting your LPU is easy if you follow a few simple steps:

- Never over-tighten the sensor.
- Always screw in your sensor by hand to avoid cross-threading. Thread failure can be a problem if you damage threads by over-tightening them or by crossing threads.

i IMPORTANT: Do not over tighten! The sensor should be threaded in only hand tight.

• Electrical Installation

For normal operation, connect the provided cable to your control system:

- Connect the red wire to +24 VDC.
- Connect the black wire to 4-20 mA input. Circuit load resistance + input resistance must be greater than 150Ω. 249Ω is recommended for optimal signal transmission.
- Refer to drawing 9002747 (page 42) for Intrinsically Safe installation.
- Refer to drawing 9002745 (page 43) for hazardous location installation.

For programming:

- Connect (+) terminal of RST-4101 to +24 VDC supply of sensor (red wire).
- Connect (-) terminal of RST-4101 to 4-20 mA signal from sensor (black wire).
- Ensure that load resistor is between RST-4101 and control network or PLC, rather than between sensor and RST-4001. (See Figure 2.2)

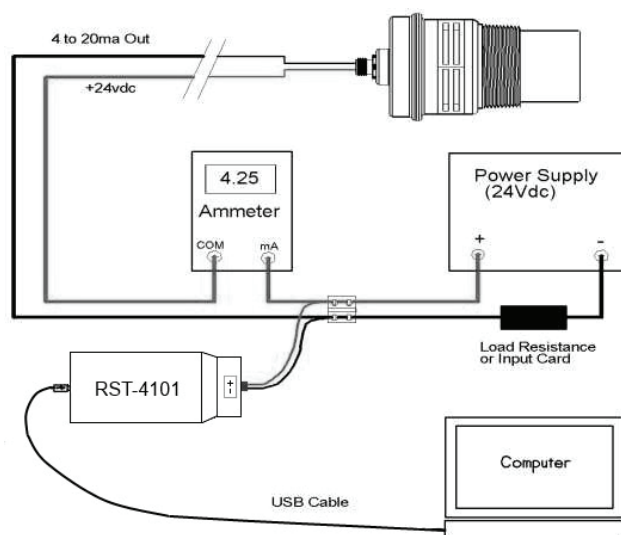



Figure 2.2

- **Software Installation**

- Download the LPU-2428A / RST-4101 software zip file from <http://apgsensors.com/support>.
- Open the zip file.
- Choose "Install" from the options at the top of the zip file window.
- The installation process will prompt you as needed to complete the installation.
- The software will create and run from a folder in your start menu titled "APG".

- **Removal Instructions**

- Ensure that power to the sensor is off.
- Disconnect the cable from the sensor.
- Remove the sensor and store it in a dry place, at a temperature between -40° F and 180° F.
- If the sensor was installed in a hazardous location, ensure that the cable will not be energized while the sensor is disconnected.

 **DANGER:** Do not disconnect equipment installed in hazardous locations unless power has been switched off or area is known to be non-hazardous.

Chapter 3: Maintenance

- **General Care**

Your LPU-2428 ultrasonic sensor is very low maintenance and will need little care as long as it was installed correctly. However, in general, you should:

- Avoid applications for which the sensor was not designed, such as extreme temperatures, contact with incompatible corrosive chemicals and fumes, or other damaging environments.
- Inspect the threads whenever you remove the sensor from duty or change its location.

• **Trouble Shooting**

Should you have problems with your LPU-2428, here are some troubleshooting steps.

- Check the received signal strength (just to left of the three Help buttons in the lower right corner. See Figure 4.32). If the signal strength is low, alternately increase Pulses and Sensitivity (Figure 4.30) until the signal strength improves.
- Ensure Temperature Compensation (Figure 4.30) is turned on.
- Set the Gain Control to AutoSense (Figure 4.30).
- Ensure that Blanking (Figure 4.30) is accurately set to account for any unwanted targets between the sensor and the closest acceptable target.

• **Calibration**

This procedure uses targets at known distances to calibrate the sensor's accuracy. A wall or other large, flat object is recommended for the long range target.

- Point the sensor at a target at a known distance near the maximum range of the sensor, 25' for a single solid object (See Figure 3.1).
- Adjust the Multiplier value until the distance reading on the sensor matches the actual measured distance to the target (See Figure 4.29).
- Point the sensor at a target near the minimum measurement range, 1' plus any Blanking distance (See Figure 3.2).
- Adjust the Offset value until the distance reading on the sensor matches the actual measured distance to the target (See Figure 4.29).
- Repeat previous two steps until no further adjustment is required.

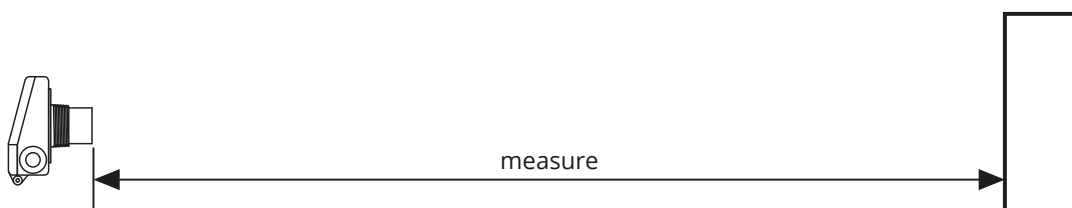

Figure 3.1

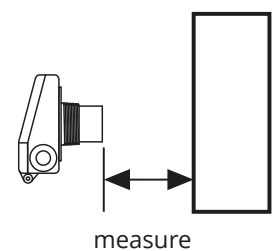

Figure 3.2

 NOTE: The Reset parameter in the Utilities Menu (Figure 4.31) will reset the LPU-2428 to factory default settings.

• **Repair and Returns**

Should your LPU-2428 ultrasonic sensor require service, please contact the factory via phone, email, or online chat. We will issue you a Return Material Authorization (RMA) number with instructions.

- Phone: 888-525-7300
- Email: sales@apgsensors.com
- Online chat at www.apgsensors.com

Please have your LPU-2428's part number and serial number available. See Warranty and Warranty Restrictions for more information.

Chapter 4: Programming and Parameter Configuration

- **Software User Interface**

The LPU-2428A / RST-4101 software user interface is one screen with five primary areas (See Figure 4.1). In the upper left are seven Menu Buttons. These buttons control the information viewed in the Display Area. Below the Menu Buttons and Display Area are six Status Boxes in two columns. Under the right hand column of Status Boxes are three Control Buttons. Three Help Buttons are located in the lower right hand corner of the screen.

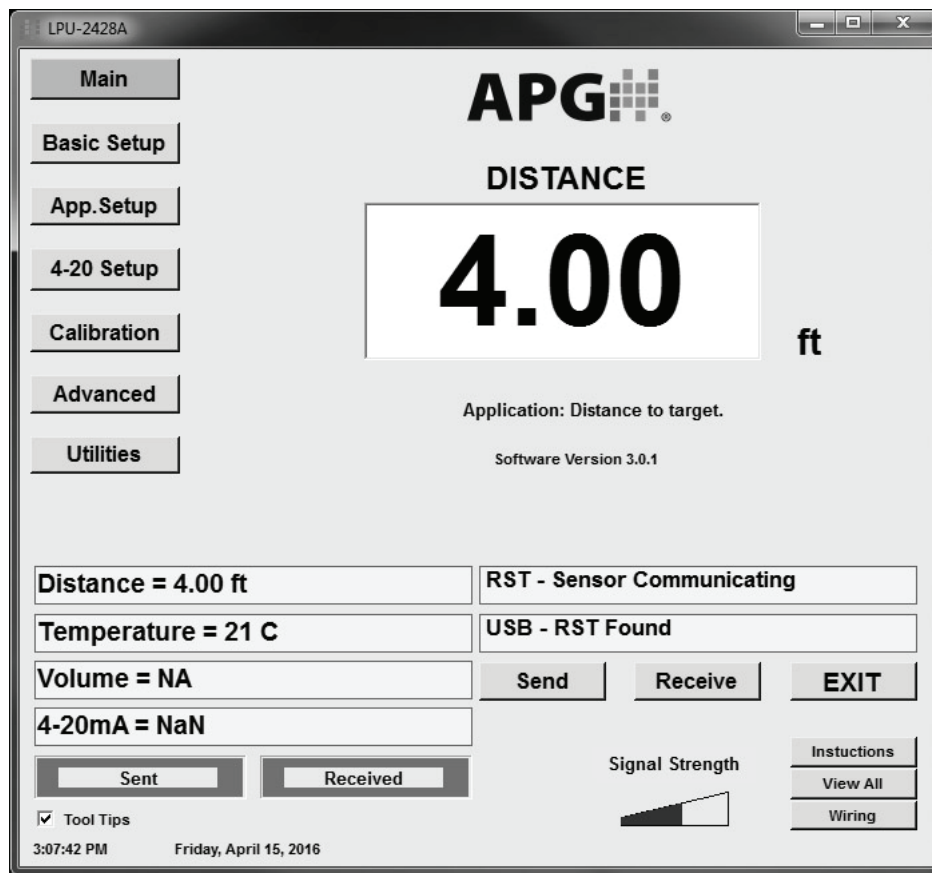

Figure 4.1

The two Status Boxes in the right column show the status of communication between the RST-4101 and the sensor, and between the LPU-2428A software and the RST-4101 (See Figure 4.2).

If an error is indicated, then check for proper connections. Allow a moment for the communication to be established while watching the status box to indicate "Sensor Communicating". If this fails to establish communication, plug the USB cable into another USB port on the computer. After communication is established, click on the "Receive" button to load the sensor settings into the software.

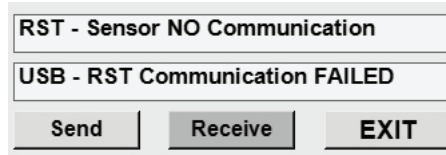

Figure 4.2

Along the bottom of the LPU-2428A software screen are two communication status boxes and a signal strength display (See Figure 4.3a). The Sent and Received Status Boxes indicate whether the last communication between the software and the sensor was successfully completed. After the Send or Receive Button is clicked, the corresponding Status Box will show the progress of the communication (See Figure 4.4b).

The Signal Strength display indicates the strength of the communication signal being received back by the software from the LPU-2428.



Figure 4.3a

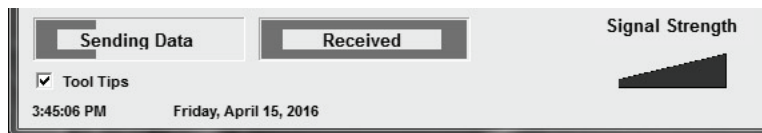

Figure 4.3b

- **Programming the LPU-2428**

The following menus are used to program the LPU-2428 in conjunction with the LPU-2428A software. Menus in the LPU-2428A software are navigated by clicking on the desired Menu Buttons on the left side of the screen.

Main:

Displays distance, level, volume, or flow. A graphical representation is displayed for level, volume, or flow.

Basic Setup:

Menu contains Units, Application, Flow/Volume Units, Flow Rate, and Response Time.

App. Setup:

Menu contains parameters specific to the current Application selected in Basic Setup. These include Volume Tank Type, Flow Type, Max/Full Distance, Zero/Empty Distance, and values for flow or volume.

4-20 Setup:

Menu contains Min & Max mA Setpoints, Fail Safe, and Fail Safe Delay.

Calibration (not required on most applications):

Menu contains Min & Max mA Value, Min & Max mA Trim, Multiplier, and Offset.

Advanced:

Menu contains Temperature Compensation, Gain Control, Sensitivity, Pulses, and Blanking.

Utilities:

Menu contains Low & High Distance Simulation, Simulation Cycle Time, Reset, File System, and Software Version.

- **Basic Setup Menu**

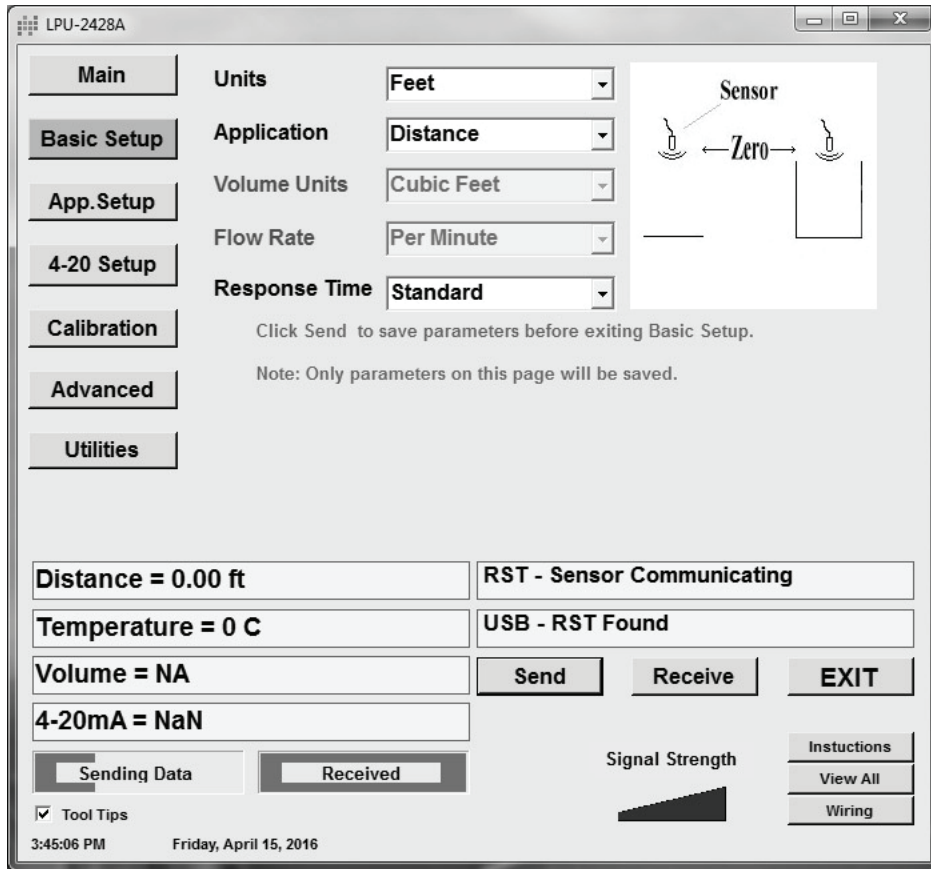

Figure 4.4

Menu	Parameter	Options
Basic Setup	<i>Units</i>	Default = Feet Feet Inches Meters Millimeters

Units selects the units of measurement that will be used throughout the setup process and also for display. The selected units also determines the resolution of the display and the outputs. The resolution is: feet 0.01, inches 0.1, 0.000 meters, and millimeters 1.

 **NOTE:** All parameter settings use the units selected in *Units*.

Menu	Parameter	Options
Basic Setup	<i>Application</i>	Default = Distance Distance Level Volume Flow Linearization Table Submersible

Application selects the measurement function of LPU-2428. Parameters for each application are configured in the App. Setup menu (See Figure 4.5). The selected application is displayed on the Main Screen under the measurement (See Figure 4.2).

Menu	Parameter	Options
Basic Setup	<i>Volume Units</i>	Default = Cubic Feet Cubic Feet Million Cubic Feet Gallons Cubic Meters Liters

Volume Units selects the units for volume measurement. *Volume Units* is greyed out in the LPU-2428A software unless *Application* is set to Volume or Flow.

Menu	Parameter	Options
Basic Setup	<i>Flow Rate</i>	Default = Per Minute Per Second Per Minute Per Hour Per Day

Flow Rate selects the units for flow rate measurement. *Volume Units* is greyed out in the LPU-2428A software unless *Application* is set to Flow.

Menu	Parameter	Options
Basic Setup	<i>Response Time</i>	Default = Standard Standard Fast Immediate

Response Time selects the desired response time of the LPU-2428. The response time represents the maximum rate of change in target level that the sensor will accurately display. A faster response time correlates to a less stable output.

- **App. Setup Menu**

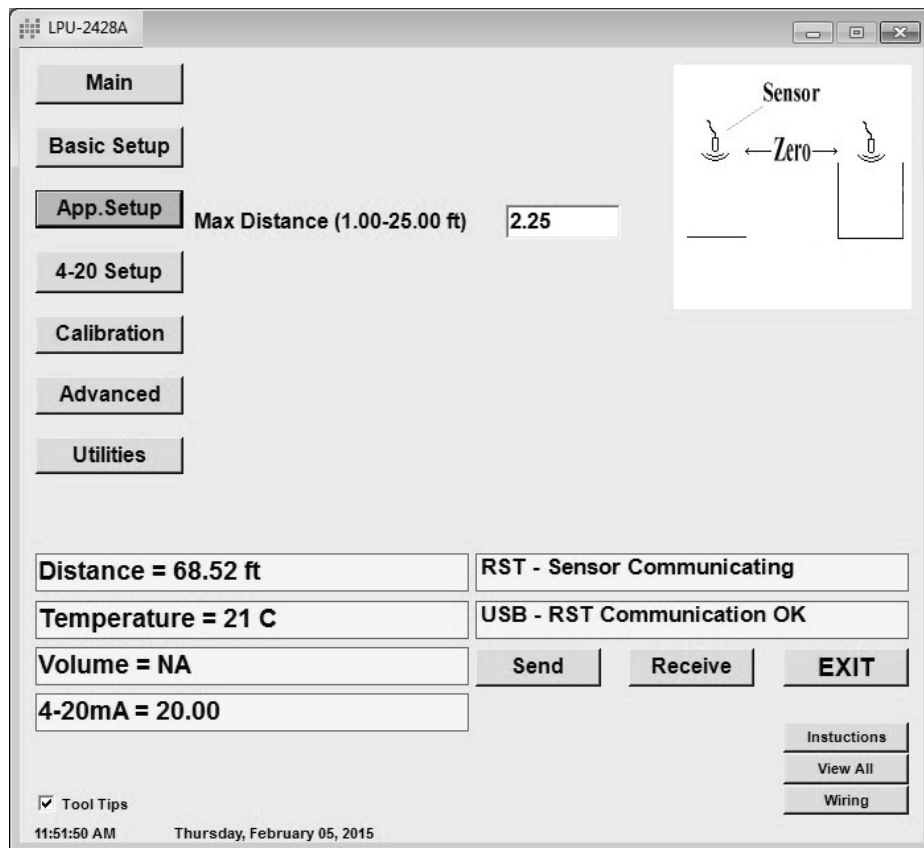

Figure 4.5

App Function	Parameter	Options
Distance	<i>Max Distance</i>	Default = 25.00 Feet 1.00 - 25.00 Feet 12.0 - 300.0 Inches 0.305 - 7.620 Meters 305 - 7620 Millimeters

Max Distance sets the maximum operating range for the LPU-2428. 25 feet is the physical limit of the LPU-2428. (See Figure 4.5)

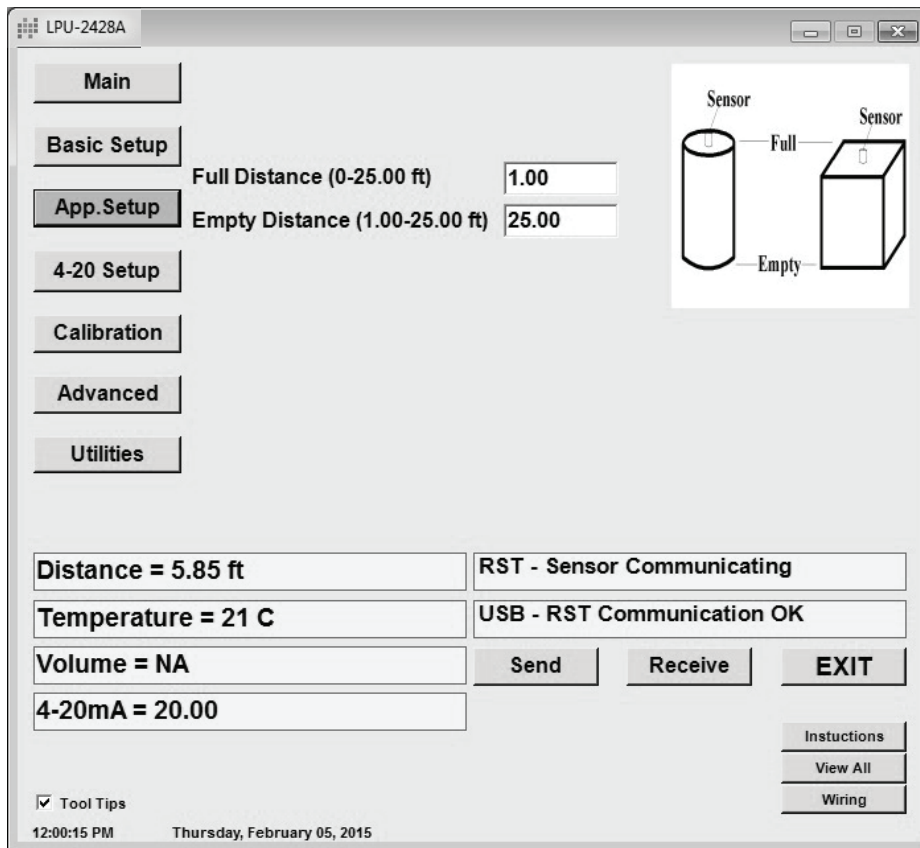

Figure 4.6

App Function	Parameter	Options
Level	<i>Full Distance</i>	Default = 1.00 Feet 0.00 - 25.00 Feet 00.0 - 300.0 Inches 0.000 - 7.620 Meters 000 - 7620 Millimeters

Full Distance sets the distance from the sensor to the full level of the vessel being monitored. (See Figure 4.6)

App Function	Parameter	Options
Level	<i>Empty Distance</i>	Default = 25.00 Feet 1.00 - 25.00 Feet 12.0 - 300.0 Inches 0.305 - 7.620 Meters 305 - 7620 Millimeters

Empty Distance sets the distance from the sensor to the empty level of the vessel being monitored. (See Figure 4.6)

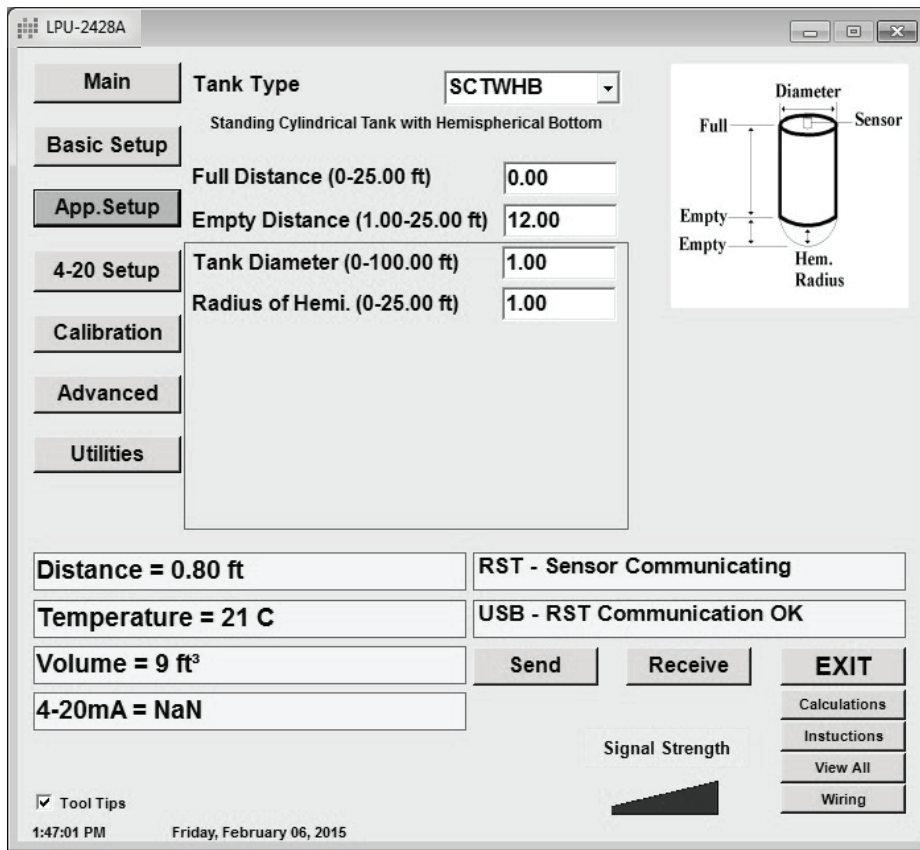

Figure 4.7

App Function	Parameter	Options
Volume	<i>Tank Type</i>	Default = SCTWHB SCTWCB SRT HCT ST

Tank Type selects the general geometry of the tank. (See Figures 4.7-4.11)

App Function	Parameter	Options
Volume	<i>Full Distance</i>	Default = 1.00 Feet 0.00 - 25.00 Feet 00.0 - 300.0 Inches 0.000 - 7.620 Meters 000 - 7620 Millimeters

Full Distance sets the distance from the sensor to the full level of the tank being monitored. (See Figures 4.7-4.11)

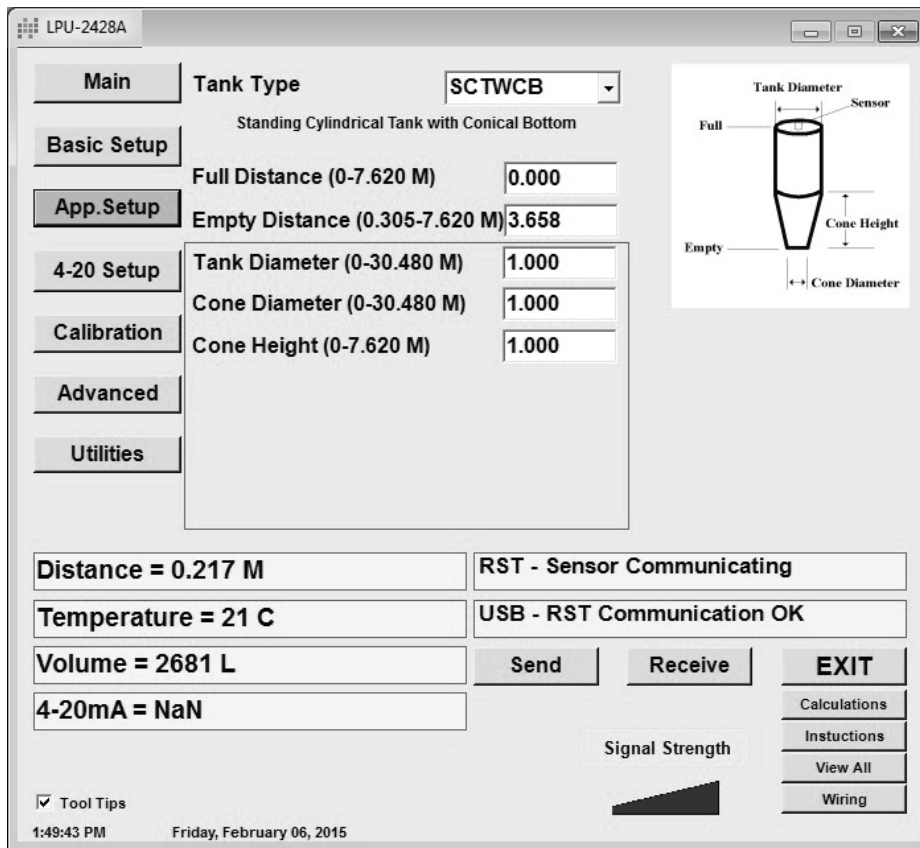

Figure 4.8

App Function	Parameter	Options
Volume	<i>Empty Distance</i>	Default = 25.00 Feet 1.00 - 25.00 Feet 12.0 - 300.0 Inches 0.305 - 7.620 Meters 305 - 7620 Millimeters

Empty Distance sets the distance from the sensor to the empty level of the tank being monitored. (See Figures 4.7-4.11)

App Function	Parameter	Options
Volume	<i>Tank Diameter</i>	Default = 1.00
SCTWHB		0.00 - 100.00 Feet
SCTWCB		00.0 - 1200.0 Inches
HCT		0.000 - 30.480 Meters
ST		000 - 30480 Millimeters

Tank Diameter sets the diameter of cylindrical (SCTWHB, SCTWCB, HCT) or spherical (ST) tank. (See Figures 4.7, 4.8, 4.10, and 4.11)

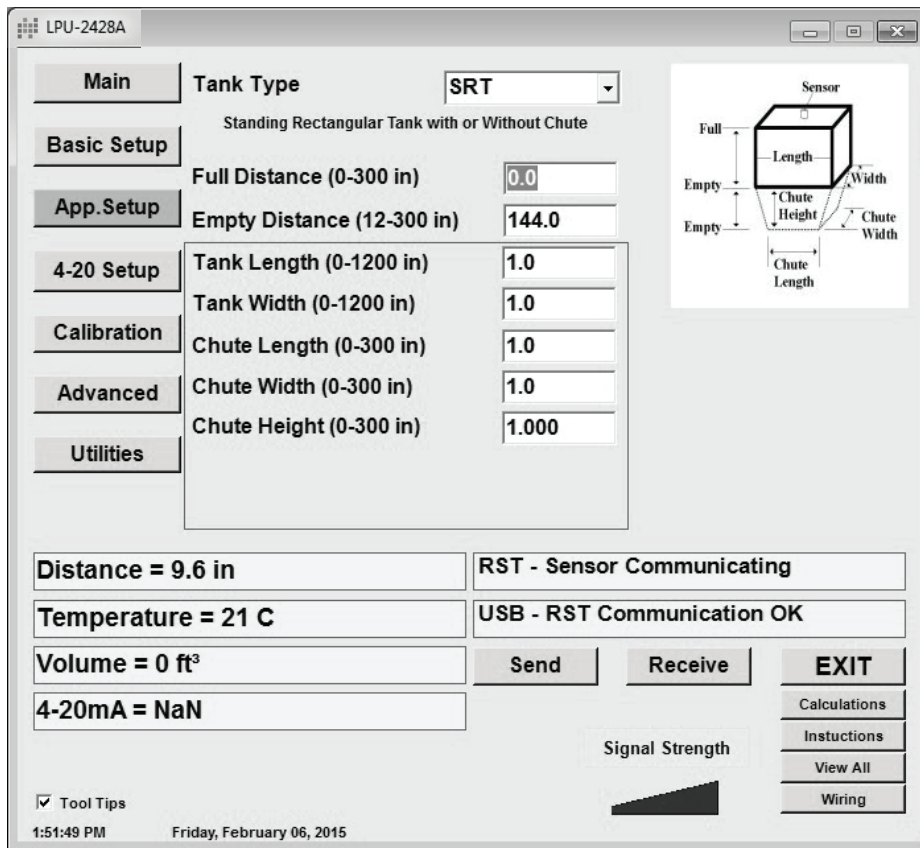

Figure 4.9

App Function	Parameter	Options
Volume	<i>Radius of Hemi</i>	Default = 1.00
SCTWHB		0.00 - 25.00 Feet
HCT		00.0 - 300.0 Inches
		0.000 - 7.620 Meters
		000 - 7620 Millimeters

Radius of Hemi sets the radius of the hemisphere on the bottom (SCTWHB) or end (HCT) of a standing or horizontal cylindrical tank. (See Figures 4.7 and 4.10)

App Function	Parameter	Options
Volume	<i>Cone Diameter</i>	Default = 1.00
SCTWCB		0.00 - 100.00 Feet
		00.0 - 1200.0 Inches
		0.000 - 30.480 Meters
		000 - 30480 Millimeters

Cone Diameter sets the lower diameter of the cone chute on a standing cylindrical tank (SCTWCB). (See Figure 4.8)

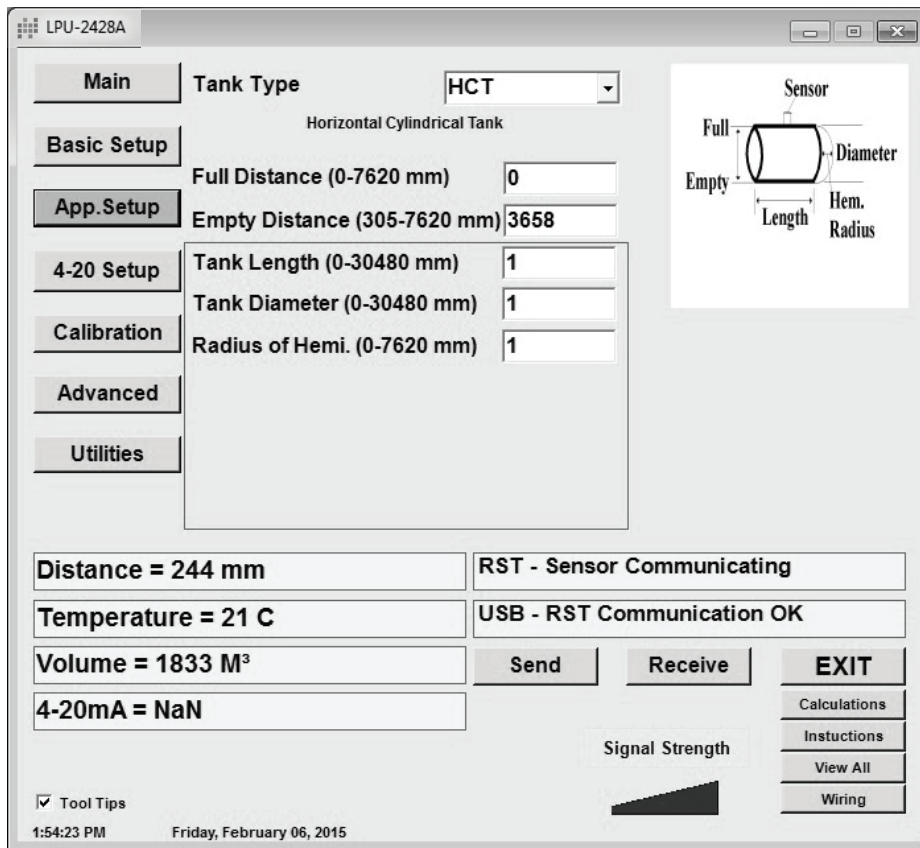

Figure 4.10

App Function	Parameter	Options
Volume SCTWCB	<i>Cone Height</i>	Default = 1.00 0.00 - 25.00 Feet 00.0 - 300.0 Inches 0.000 - 7.620 Meters 000 - 7620 Millimeters

Cone Height sets the height of the cone chute on a SCTWCB. (See Figure 4.8)

App Function	Parameter	Options
Volume SRT HCT	<i>Tank Length</i>	Default = 1.00 0.00 - 100.00 Feet 00.0 - 1200.0 Inches 0.000 - 30.480 Meters 000 - 30480 Millimeters

Tank Length sets the length of a rectangular (SRT) or horizontal cylindrical (HCT) tank. (See Figures 4.9 and 4.10)

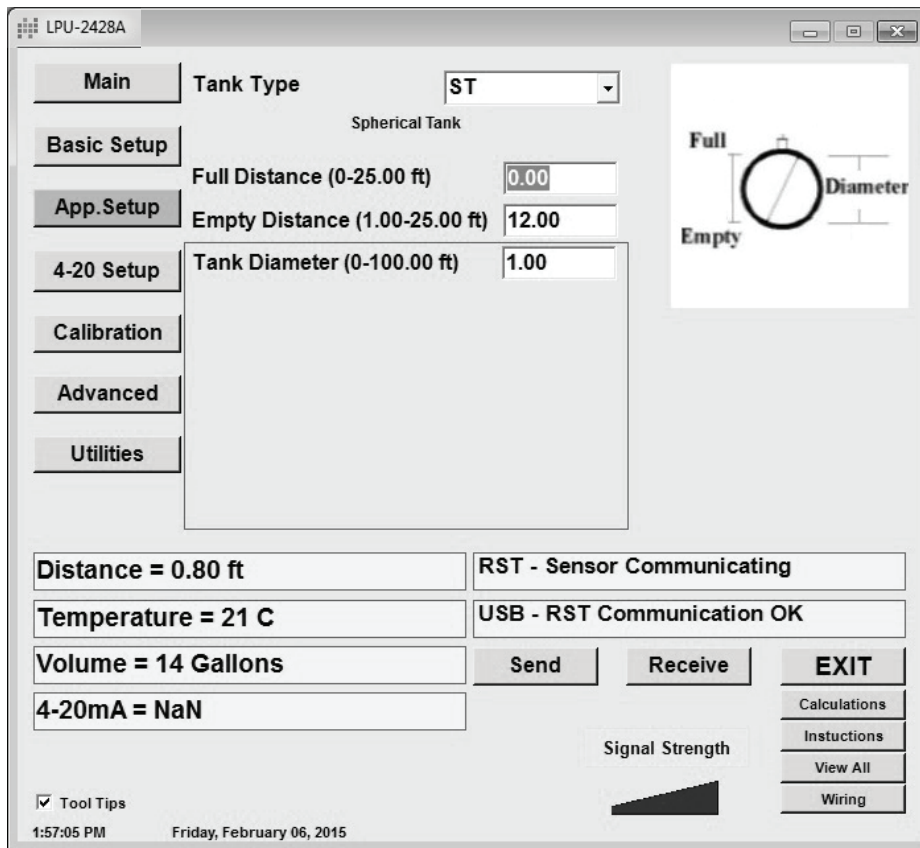

Figure 4.11

App Function	Parameter	Options
Volume SRT	<i>Tank Width</i>	Default = 1.00 0.00 - 25.00 Feet 00.0 - 300.0 Inches 0.000 - 7.620 Meters 000 - 7620 Millimeters

Tank Width sets the width of a rectangular (SRT) tank. (See Figure 4.9)

App Function	Parameter	Options
Volume SRT	<i>Chute Length</i>	Default = 1.00 0.00 - 25.00 Feet 00.0 - 300.0 Inches 0.000 - 7.620 Meters 000 - 7620 Millimeters

Chute Length sets the length of a chute under a rectangular (SRT) tank. The length of the chute is in the same direction as the length of the tank. (See Figure 4.9)

App Function	Parameter	Options
Volume	<i>Chute Width</i>	Default = 1.00 Default = 1.00
SRT (<i>C Width</i>)	0.00 - 25.00 Feet	0.00 - 25.00 Feet
	0.0 - 300.0 Inch	00.0 - 300.0 Inches
	0.000 - 7.620 Meters	0.000 - 7.620 Meters
	000 - 7620 MM	000 - 7620 Millimeters

Chute Width sets the width of a chute under a rectangular (SRT) tank. The width of the chute is in the same direction as the width of the tank. (See Figure 4.9)

App Function	Parameter	Options
Volume	<i>Chute Height</i>	Default = 1.00
SRT		0.00 - 25.00 Feet
		00.0 - 300.0 Inches
		0.000 - 7.620 Meters
		000 - 7620 Millimeters

Chute Height sets the height of a chute under a rectangular (SRT) tank. (See Figure 4.9)

App Function	Parameter	Options
Flow	<i>Flow Type</i>	Default = Flume
		Flume
		Weir
		Equation

Flow Type selects the type of flow being monitored. (See Figures 4.12-4.22)

App Function	Parameter	Options
Flume	<i>Flume Type</i>	Default = Parshall
		Parshall
		Cut Throat

Flume Type selects the type of flume being monitored. (See Figure 4.12-4.13)

App Function	Parameter	Options
Weir	<i>Weir Type</i>	Default = California Pipe
		California Pipe
		Rectangle w/Const
		Rectangle w/o Const
		Trapazoidal
		Triangular or V-Notch

Weir Type selects the type of weir being monitored. (See Figure 4.14-4.18)

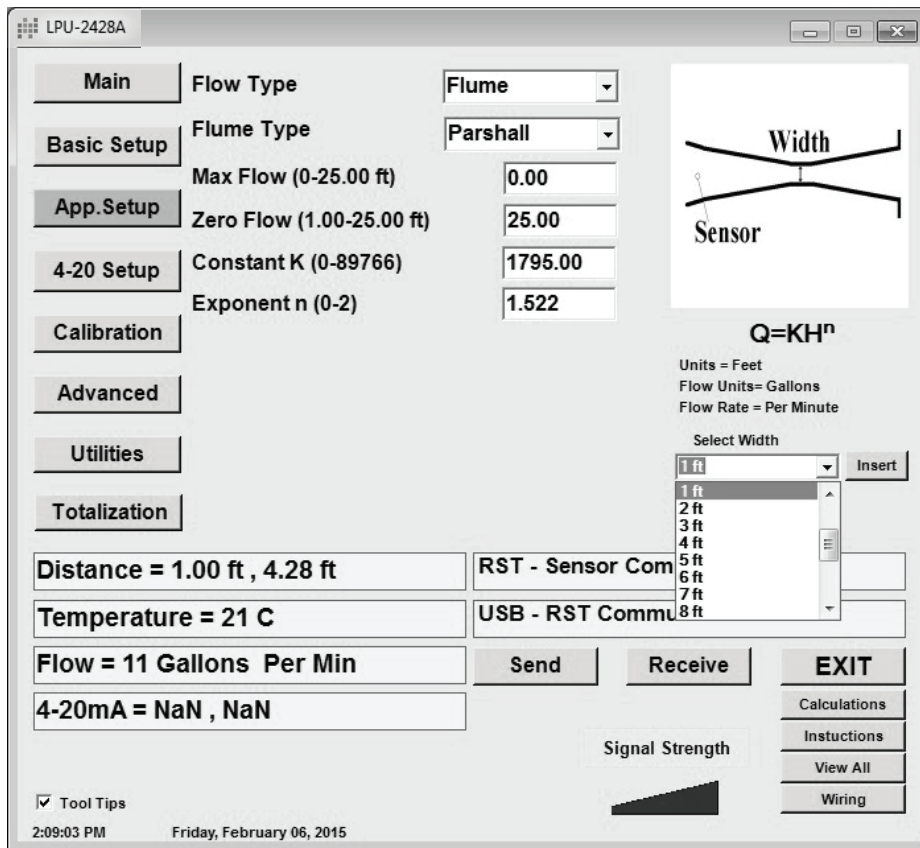

Figure 4.12

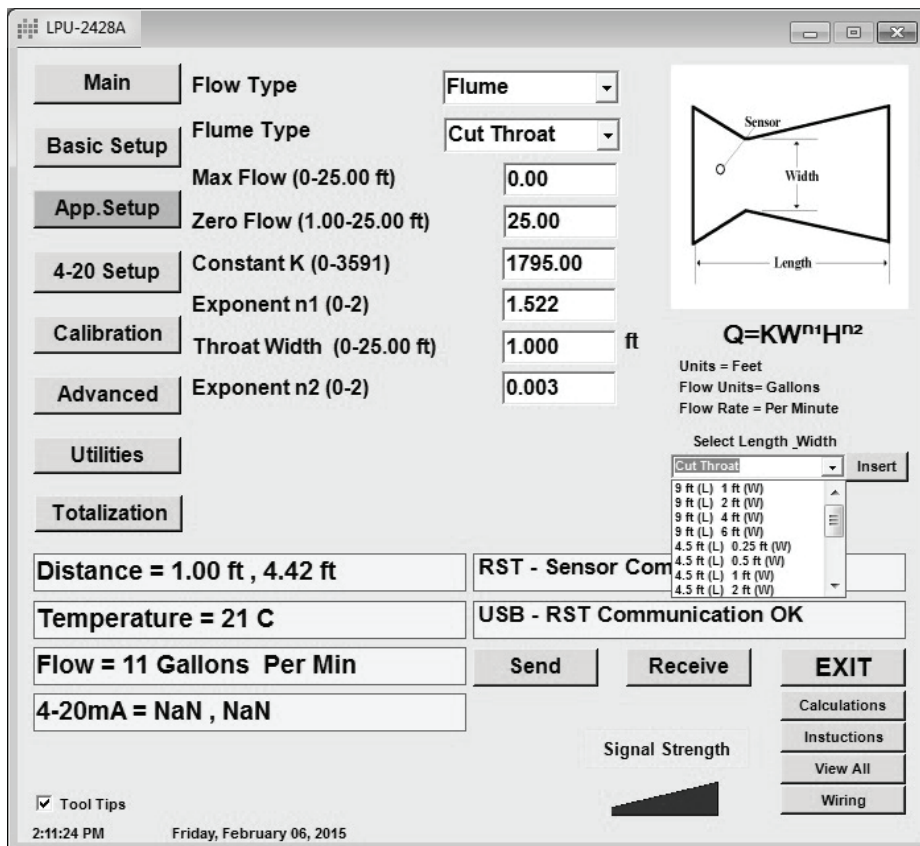

Figure 4.13



Figure 4.14

App Function	Parameter	Options
Equation	Equation	Default = $Q=KH^n$ $Q=KH^n$ $Q=KLH^n$ $Q=K[L-XH]H^n$ $Q=K[B-A/D]^{n1}P^{n2}$

Equation selects the equation that best models the flow being monitored. (See Figure 4.19-4.22)

App Function	Parameter	Options
Flow	Max Flow	Default = 1.00 0.00 - 25.00 Feet 00.0 - 300.0 Inches 0.000 - 7.620 Meters 000 - 7620 Millimeters

Max Flow sets the distance from the sensor to the maximum height of the flow. (See Figures 4.12-4.22)

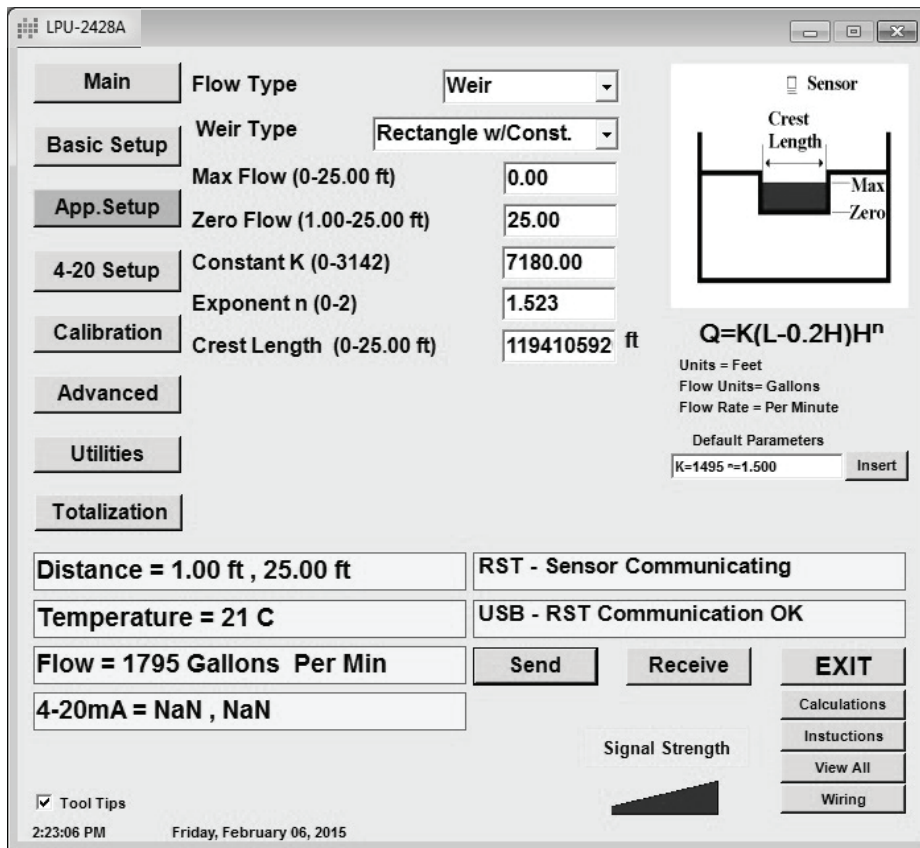

Figure 4.15

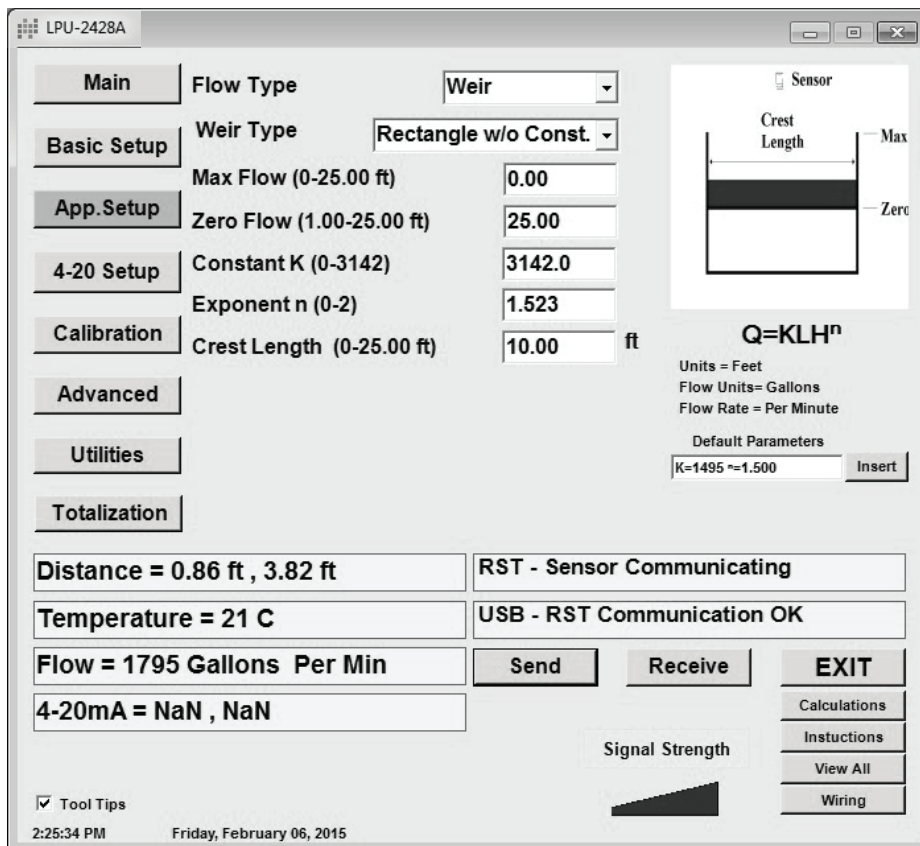

Figure 4.16

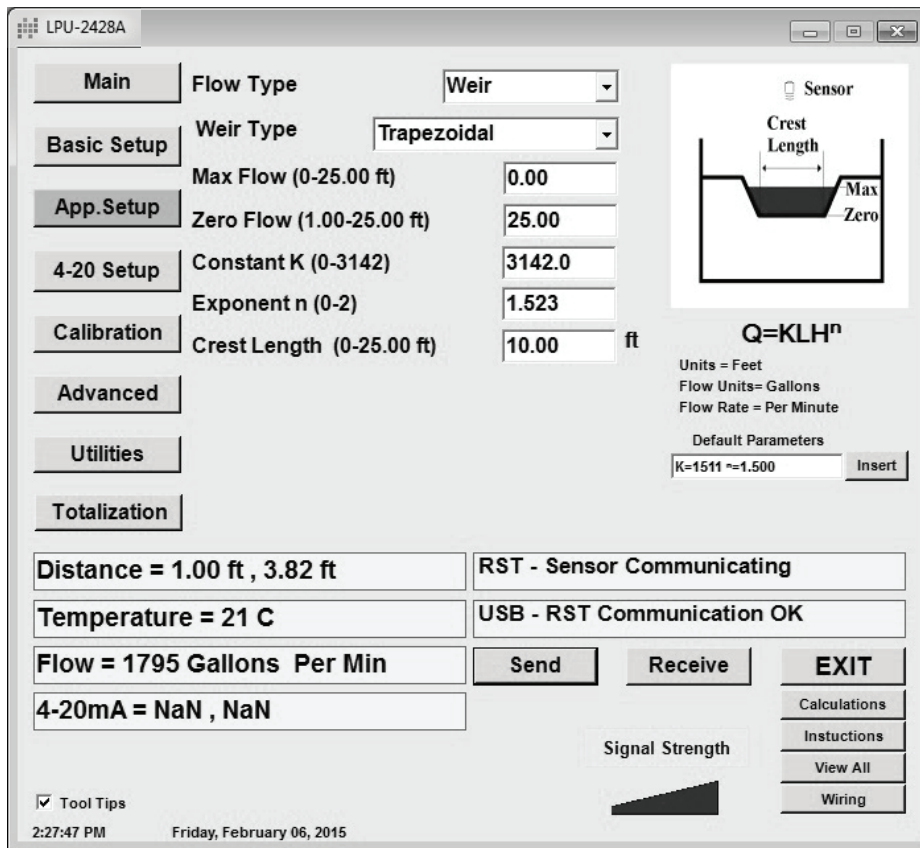

Figure 4.17

App Function	Parameter	Options
Flow	<i>Zero Flow</i>	Default = 1.00 0.00 - 25.00 Feet 00.0 - 300.0 Inches 0.000 - 7.620 Meters 000 - 7620 Millimeters

Zero Flow sets the distance from the sensor to the level of minimum flow. (See Figure 4.12-4.22)

App Function	Parameter	Options
Flow	<i>Constant K</i>	Default = Varies

Constant K sets the flow coefficient K for the channel being monitored. The range for K varies for each application. Flume configurations have selectable widths that provide appropriate K values. Weir configurations include suggested K values on the right side of the screen. (See Figures 4.12-4.22)

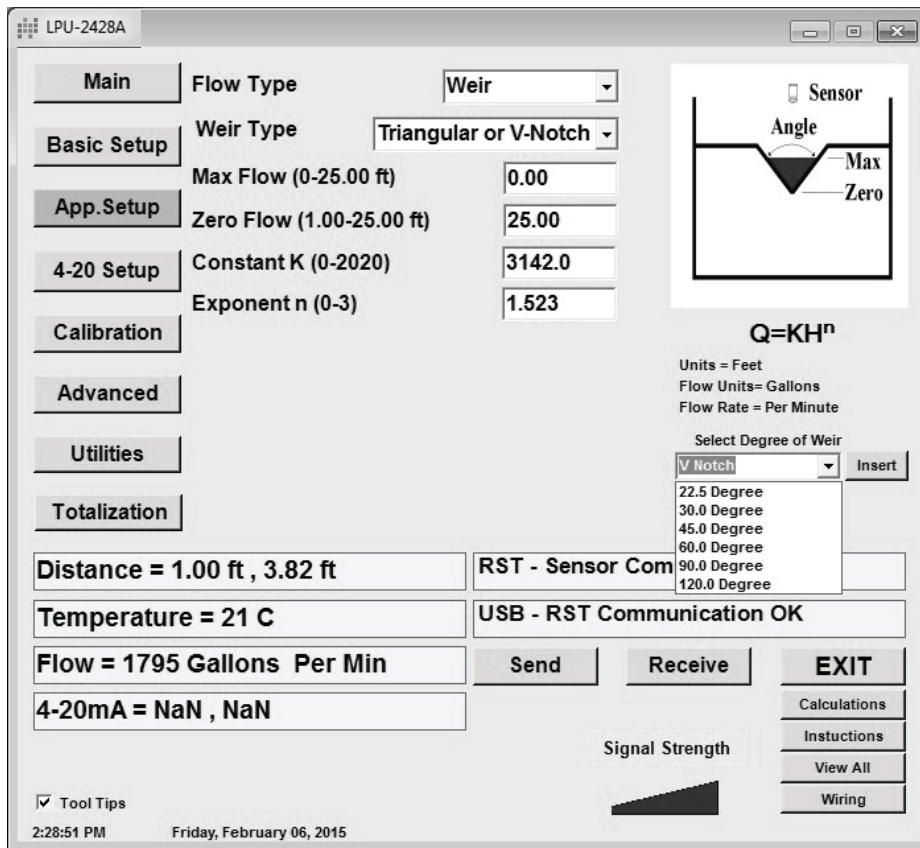

Figure 4.18

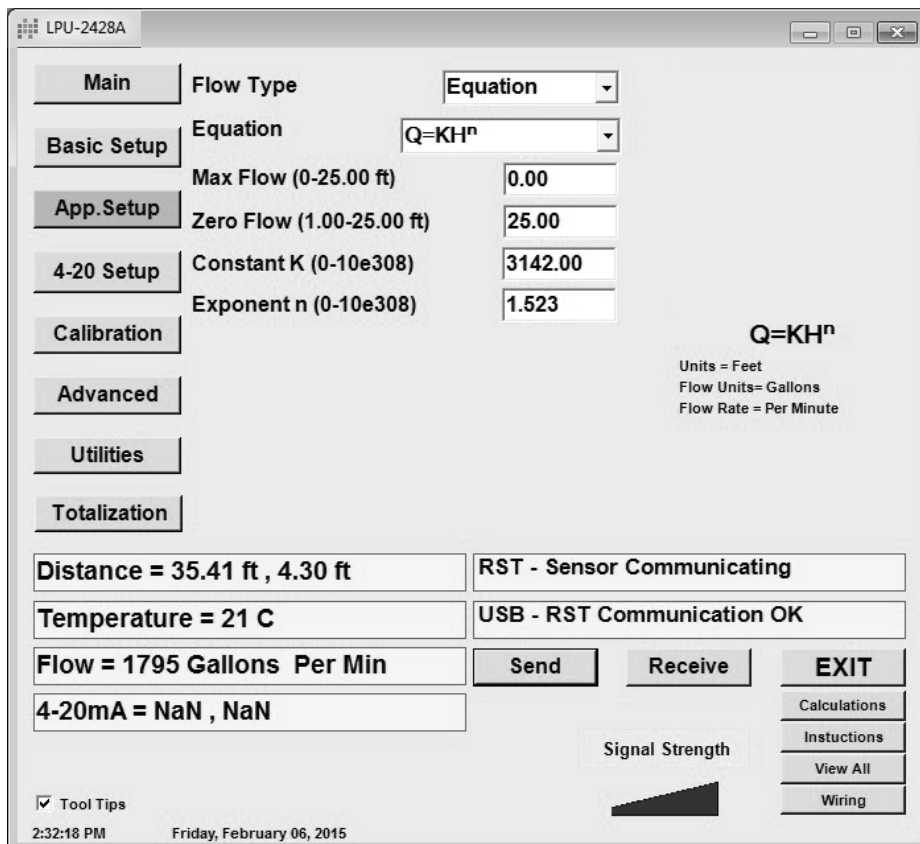

Figure 4.19

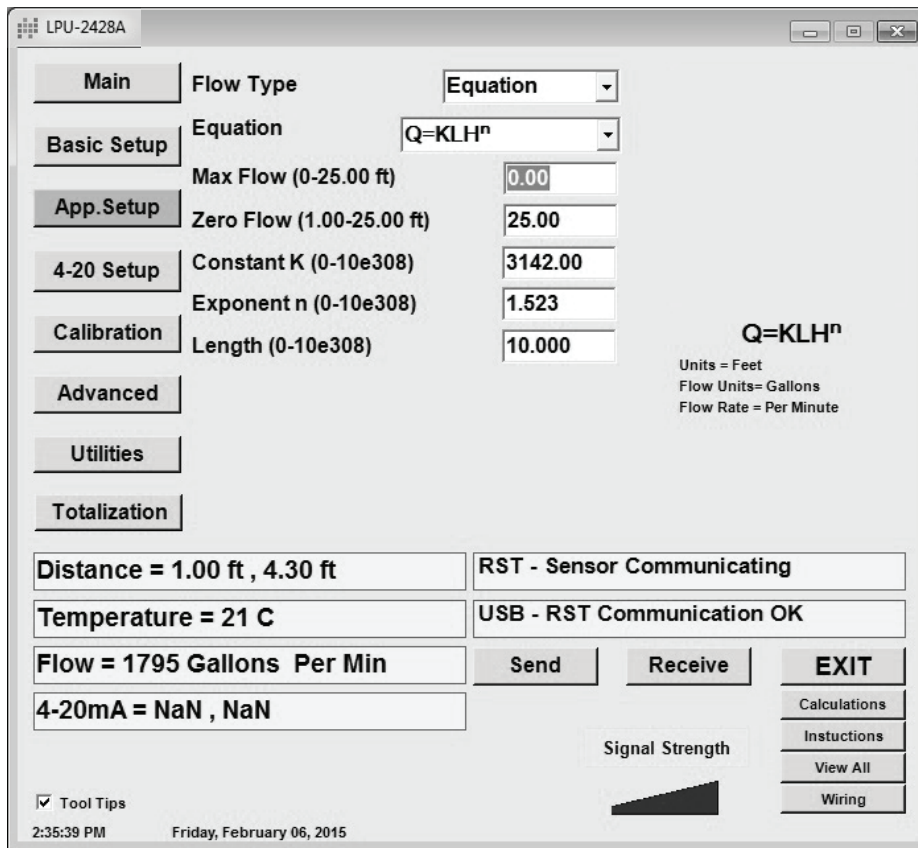

Figure 4.20

App Function	Parameter	Options
Flow	<i>Exponent n / n1</i>	Default = varies

Exponent n or *n1* sets the value of the (first) exponent for the channel being monitored. The range for *n* or *n1* varies for each application. Flume configurations have selectable widths that provide appropriate *n* or *n1* values. Weir configurations include suggested *n* or *n1* values on the right side of the screen. (See Figures 4.12-4.22)

App Function	Parameter	Options
Flow	<i>Exponent n2</i>	Default = varies
Cutthroat (<i>N2</i>)		
Cal. Pipe		
$Q=K[B-A/D]^{n1}P^{n2}$		

Exponent n2 sets the value of the second exponent for Cutthroat flume and California pipe weirs being monitored. The range for *n2* varies for each application. Flume configurations have selectable widths that provide appropriate *n2* values. Weir configurations include suggested *n2* values on the right side of the screen. (See Figures 4.13, 4.14, and 4.22)

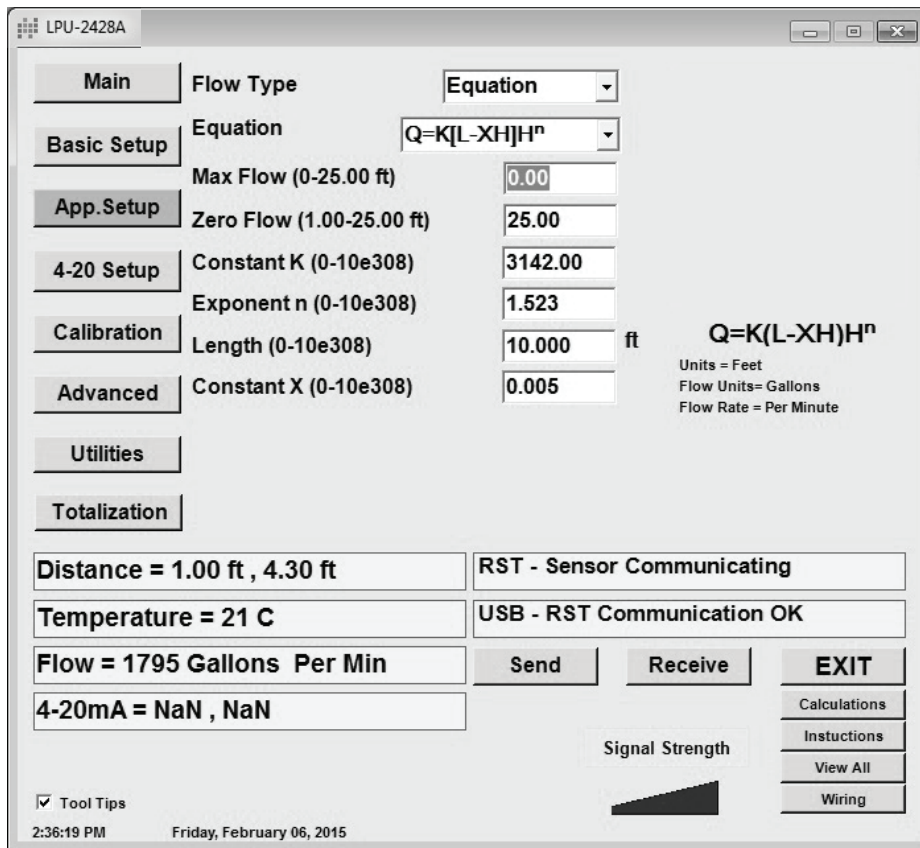

Figure 4.21

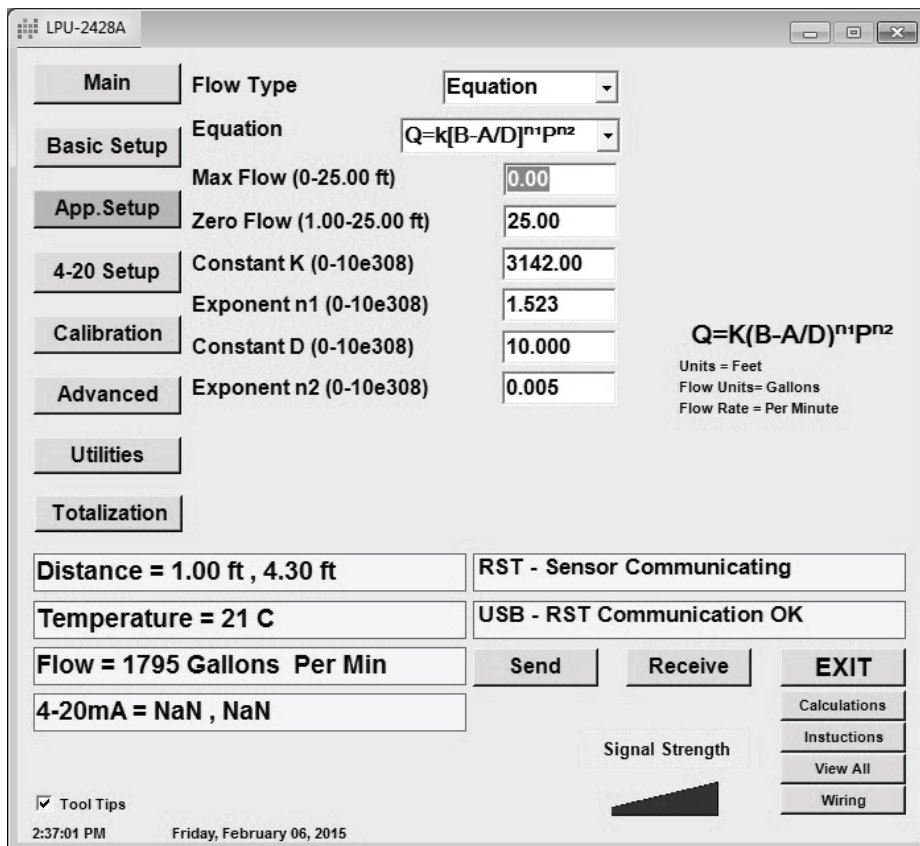

Figure 4.22

App Function	Parameter	Options
Flow - Flume Cut Throat	<i>Throat Width</i>	Default = 1.00 0.00 - 25.00 Feet 00.0 - 300.0 Inches 0.000 - 7.620 Meters 000 - 7620 Millimeters

Throat Width sets the width of a Cut Throat flume. Length and width combinations can be selected from the right side of the screen. (See Figure 4.13)

App Function	Parameter	Options
Flow - Weir Calif. Pipe	<i>Diameter of Pipe</i>	Default = 1.00 0.00 - 25.00 Feet 00.0 - 300.0 Inches 0.000 - 7.620 Meters 000 - 7620 Millimeters

Diameter of Pipe sets the diameter of a California Pipe type weir. (See Figure 4.14)

App Function	Parameter	Options
Flow - Weir Rect w/cst Rect w/o cst Trapezoidal	<i>Crest Length</i>	Default = 1.00 0.00 - 25.00 Feet 00.0 - 300.0 Inches 0.000 - 7.620 Meters 000 - 7620 Millimeters

Crest Length sets the crest length for Rectangular (with and without constriction) and Trapezoidal weirs. (See Figures 4.15, 4.16, and 4.17)

App Function	Parameter	Options
Flow - Equation $Q=KLH^n$ $Q=K[L-XH]H^n$	<i>Length</i>	Default = 10.000 0 - 10e308 (ft)

Length sets the value of the L variable in the flow equations. Length can be set using the RST-4001, but can only be adjusted by 0.001 increments using the UP and DOWN arrows. (See Figures 4.20, 4.21, and 4.1)

App Function	Parameter	Options
Flow - Equation $Q=K[L-XH]H^n$	<i>Constant X</i>	Default = 0.006 0 - 10e308

Constant X sets the value of the X constant in the flow equation $Q=K[L-XH]H^n$. (See Figures 4.21)

App Function	Parameter	Options
Flow - Equation $Q=K[B-A/D]^{n1}P^{n2}$	<i>Constant D</i>	Default = 10.000 0 - 10e308

Constant D sets the value of the D constant in the flow equation $Q=K[B-A/D]^{n1}P^{n2}$. (See Figures 4.22)

App Function	Parameter	Options
Linearization Table	<i>Max Distance</i>	Default = 1.00 Feet 0.00 - 25.00 Feet 00.0 - 300.0 Inches 0.000 - 7.620 Meters 000 - 7620 Millimeters

Max Distance sets the distance from the sensor to the point of maximum volume for a linear table. (See Figure 4.23)

App Function	Parameter	Options
Linearization Table	<i>Zero Distance</i>	Default = 20.00 Feet 1.00 - 25.00 Feet 12.0 - 300.0 Inches 0.305 - 7.620 Meters 305 - 7620 Millimeters

Zero Distance sets the distance from the sensor to the point of zero volume for a linear table. (See Figure 4.23)

App Function	Parameter	Options
Submersible	<i>Submersible Range</i>	Default = 1.00 Feet 0.00 - 25.00 Feet 00.0 - 300.0 Inches 0.000 - 7.620 Meters 000 - 7620 Millimeters

Sumersible Range sets distance from the sensor to point at which a hypothetical pressure transducer would be submerged. (See Figure 4.24)

App Function	Parameter	Options
Submersible	<i>Depth Distance</i>	Default = 20.00 Feet 0.00 - 25.00 Feet 00.0 - 300.0 Inches 0.000 - 7.620 Meters 000 - 7620 Millimeters

Depth Distance represenents the equivalent depth for the 20mA output setting of the hypothetical pressure transducer. (See Figures 4.24 and 4.25)

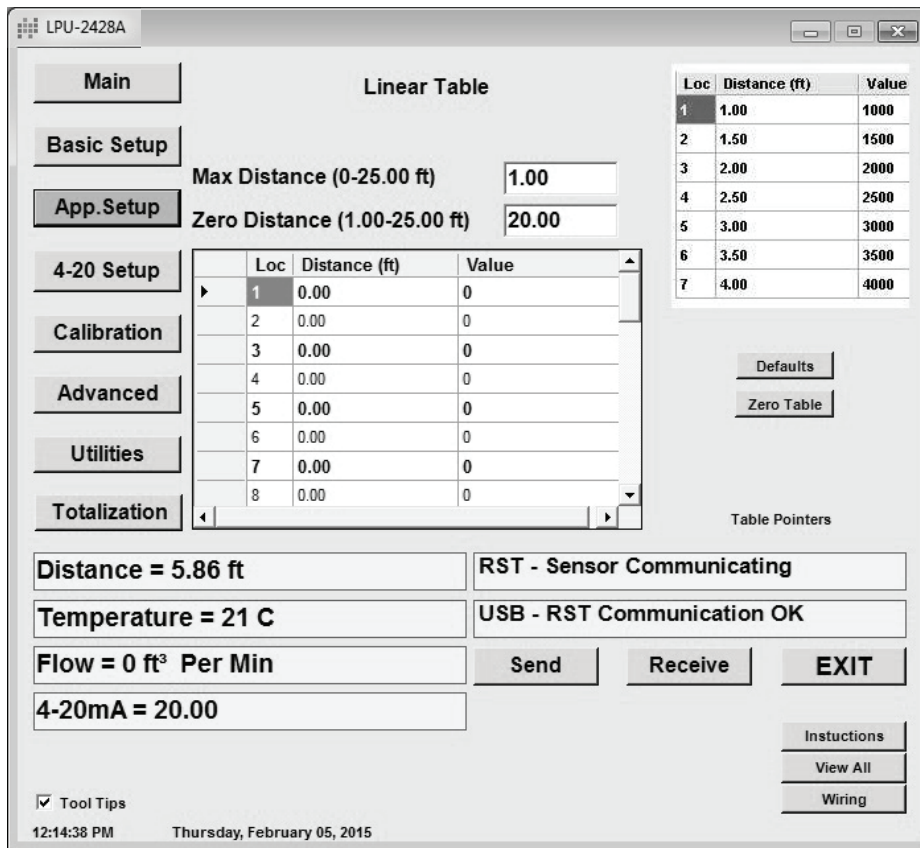

Figure 4.23

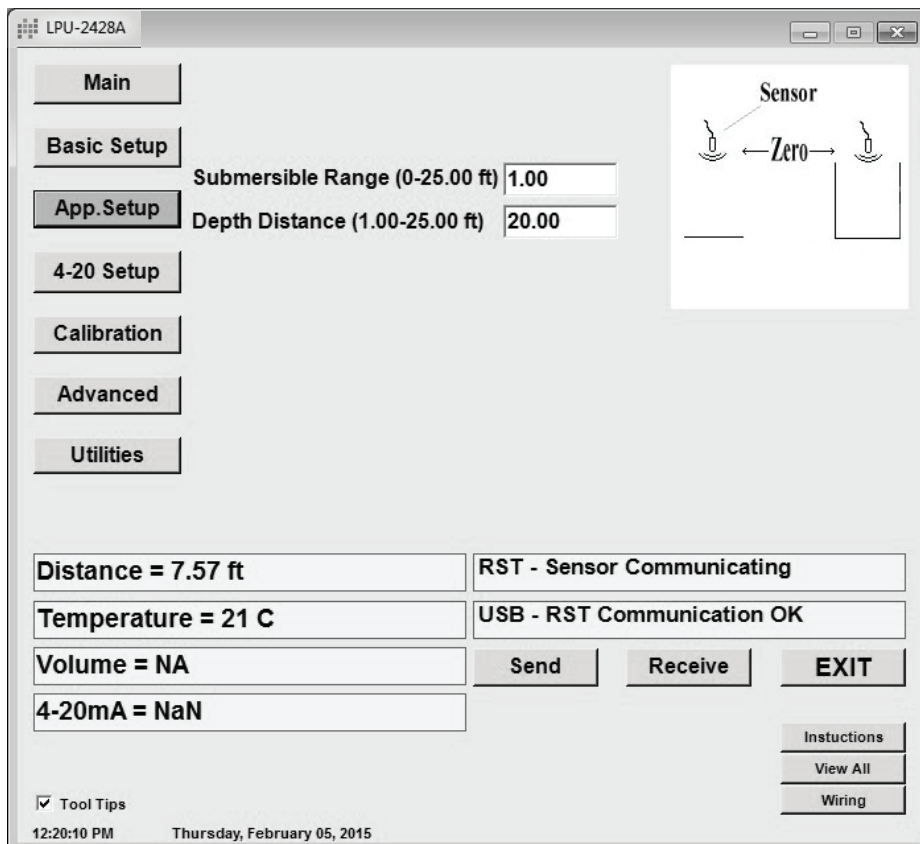

Figure 4.24

Transducer PSI to Milliamp Chart											
0-5 PSI	milliamp	Feet	0-10 PSI	milliamp	Feet	0-15 PSI	milliamp	Feet	0-100 PSI	milliamp	Feet
0	4.0	0.0	0	4.0	0.0	0	4.0	0.0	0	4.0	0.0
1	7.2	2.3	1	5.6	2.3	1	5.1	2.3	5	4.8	11.6
2	10.4	4.6	2	7.2	4.6	2	6.1	4.6	10	5.6	23.1
3	13.6	6.9	3	8.8	6.9	3	7.2	6.9	15	6.4	34.7
4	16.8	9.2	4	10.4	9.2	4	8.3	9.2	20	7.2	46.2
5	20.0	11.6	5	12.0	11.6	5	9.3	11.6	25	8.0	57.8
			6	13.6	13.9	6	10.4	13.9	30	8.8	69.3
			7	15.2	16.2	7	11.5	16.2	35	9.6	80.9
			8	16.8	18.5	8	12.5	18.5	40	10.4	92.4
			9	18.4	20.8	9	13.6	20.8	45	11.2	104.0
			10	20.0	23.1	10	14.7	23.1	20	7.2	46.2
						11	15.7	25.4	22	7.5	50.8
						12	16.8	27.7	60	13.6	138.6
						13	17.9	30.0	65	14.4	150.2
						14	18.9	32.3	70	15.2	161.7
						15	20.0	34.7	75	16.0	173.3
									80	16.8	184.8
									85	17.6	196.4
									90	18.4	207.9
									95	19.2	219.5
									100	20.0	231.0

Figure 4.25

- 4-20 Setup Menu

Menu	Parameter	Distance/Level Options
4-20 Setup	<i>Min mA Setpoint</i>	Default = 1.00 Feet 0.00 - 25.00 Feet 0.0 - 300.0 Inches 0.000 - 7.620 Meters 0000 - 7620 Millimeters

Min mA Setpoint sets the distance from the sensor to the level corresponding to minimum output (4mA). (See Figures 4.26 - 4.28)

Menu	Parameter	Distance/Level Options
4-20 Setup	<i>Max mA Setpoint</i>	Default = 20.00 Feet 0.00 - 25.00 Feet 0.0 - 300.0 Inches 0.000 - 7.620 Meters 0000 - 7620 Millimeters

Max mA Setpoint sets the distance from the sensor to the level corresponding to maximum output (20mA). (See Figures 4.26 - 4.28)

 NOTE: Parameter Options will change for Applications other than Distance or Level.



Figure 4.26

Menu	Parameter	Options
4-20 Setup	<i>Fail Safe</i>	Default = Hold Hold 3.8 mA 22mA

Fail Safe sets the output condition that the sensor will revert to in the event of a loss of echo condition. If Fail Safe is set to Hold, the sensor will hold the last reading until the signal is regained. (See Figure 4.26)

Menu	Parameter	Options
4-20 Setup	<i>Fail Safe Delay</i>	Default = 15 sec 15 - 9999 sec

Fail Safe sets the delay, in seconds, before the output shows the loss of echo condition set in Fail Safe. When this time has expired, the output will change to the Fail Safe settings. (See Figure 4.26)

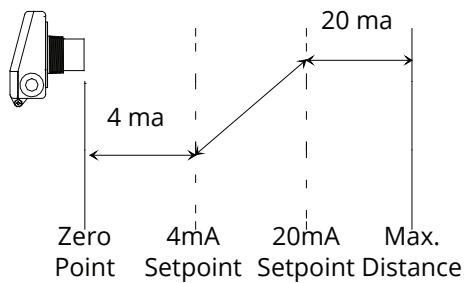

Figure 4.27

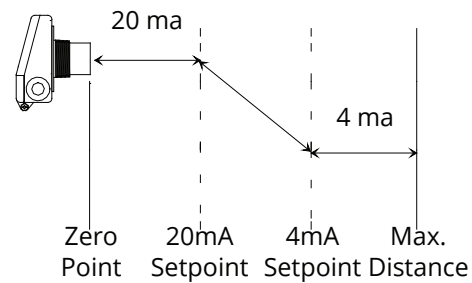

Figure 4.28

• Calibration Menu

Menu	Parameter	Options
Calibration	<i>Min mA Value</i>	Default = 4.00 4.00 - Max mA Value

Min mA Value sets the minimum current output of the sensor. (See Figure 4.29)

Menu	Parameter	Options
Calibration	<i>Max mA Value</i>	Default = 20.00 Min mA Value - 20.00

Max mA Value sets the maximum current output of the sensor. (See Figure 4.29)

Menu	Parameter	Options
Calibration	<i>Min mA Trim</i>	Default = 500 0 - 999

Min mA Trim fine tunes the minimum current output of the sensor. (See Figure 4.29)

Menu	Parameter	Options
Calibration	<i>Max mA Trim</i>	Default = 500 0 - 999

Max mA Trim fine tunes the maximum current output of the sensor. (See Figure 4.29)

Menu	Parameter	Options
Calibration	<i>Multiplier</i>	Default = 1.000 0.000 - 1.999

Multiplier calibrates the sensor for variations in the speed of sound due to variations in atmospheres. The default of 1.000 is used for most applications. (See Figure 4.29)

Menu	Parameter	Options
Calibration	<i>Offset</i>	Default = 0.00 - 3.00 - 3.00 (ft)

Offset is used to change the Zero Point of the sensor. This not the zero output (4 mA) point of the sensor. The Zero Point of the sensor is the point from which the calculated distance is measured. (See Figures 4.27, 4.28, and 4.29)

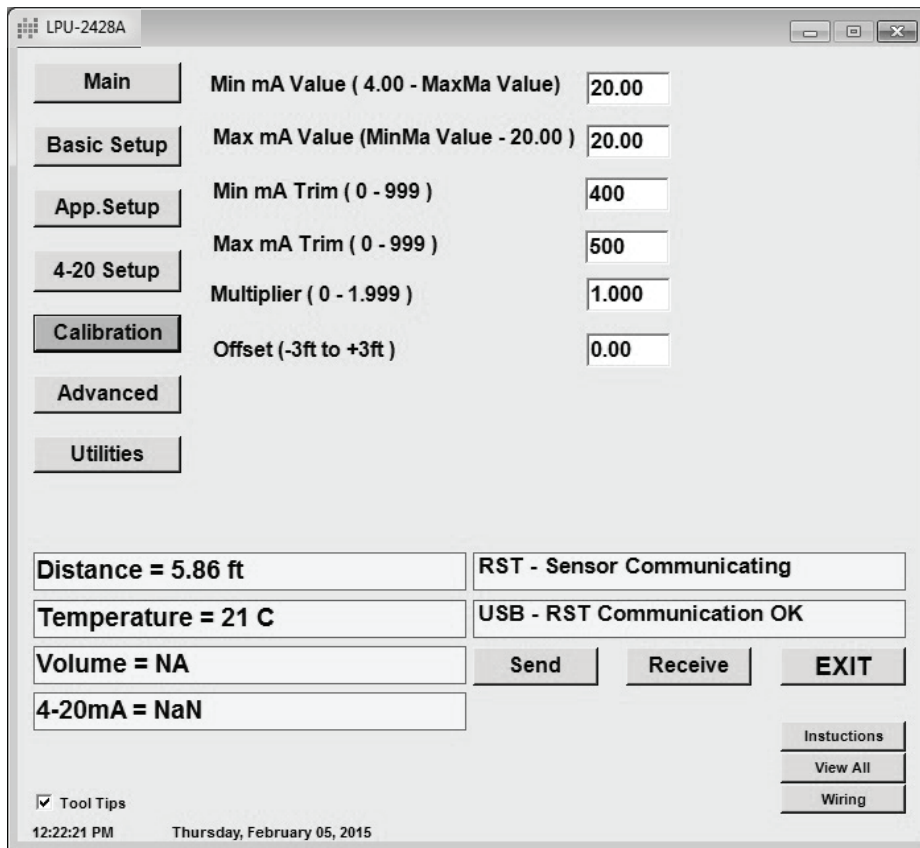

Figure 4.29

• Advanced Menu

Menu	Parameter	Options
Advanced	<i>Temp. Comp.</i>	Default = ON ON / OFF

Temperature Compensation activates or deactivates the internal temperature compensation circuit. The speed of sound changes with changes in temperature, therefore changes in temperature can affect distance measurements. (See Figure 4.30)

Menu	Parameter	Options
Advanced	<i>Gain Control</i>	Default = AutoSense Manual AutoSense Hard Target Soft Target

Gain Control selects the control mode for the sensor's gain settings (Sensitivity and Pulses). In AutoSense, the sensor automatically adjusts the sensitivity and pulses for the best quality return signal. Manual, Hard Target, and Soft Target are user controlled scenarios. In Manual, the user is in full control of sensitivity and pulses. For Hard and Soft Target, the user sets sensitivity and pulses, but the overall gain is either ramped up slowly (Hard Target) or quickly (Soft Target) by the sensor. (See Figure 4.30)

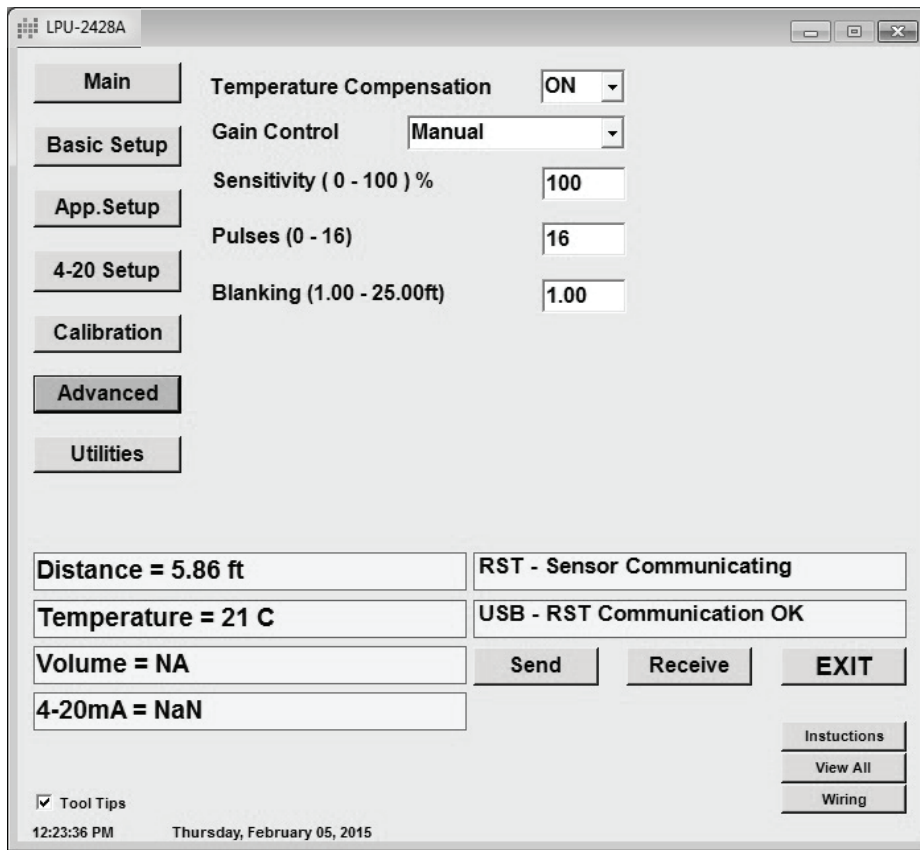

Figure 4.30

Menu	Parameter	Options
Advanced	<i>Sensitivity</i>	Default = 100% 0 - 100%

Sensitivity sets the amount of gain applied to the received signal. For gain control settings Auto Sense, Hard Target, and Soft Target, this setting limits the maximum gain applied by the sensor. (See Figure 4.30)

Menu	Parameter	Options
Advanced	<i>Pulses</i>	Default = 16 0 - 16

Pulses sets number ultrasonic pulses per transmission burst. For gain control settings Auto Sense, Hard Target, and Soft Target, this setting limits the maximum number of pulses used by the sensor. The more pulses that are sent in a burst, the stronger the returning echo. When operating in Manual, increase the strength of the transmission by increasing the number of pulses for detecting soft targets in damping environments. In acoustically active environments or small enclosed areas, decrease the number of pulses to reduce multiple echoes. (See Figure 4.30)

Menu	Parameter	Options
Advanced	<i>Blanking</i>	Default = 1.00 (ft) 1.00 - 25.00 Feet 12.0 - 300.0 Inches 0.305 - 7.620 Meters 305 - 7620 Millimeters

Blanking sets the Blanking distance, which is the zone from the sensor to a point where the first echo will be accepted. Blanking distance is used to ignore unwanted targets -- such as welds, seams, pipe fittings, or gaskets -- between the sensor and the closest acceptable target level. Because of the physical properties of an ultrasonic sensor, objects cannot be detected closer than approximately 1 foot from the face of the transducer. This distance varies according to how much energy is being transmitted and the installation. Low pulses and soft mounting may allow target detection as close as 6 inches. (See Figure 4.30)

• Utilities Menu

Menu	Parameter	Options
Utilities	<i>Low Distance Simulation</i>	Default = 1.00 (ft) 1.00 - 25.00 Feet 12.0 - 300.0 Inches 0.305 - 7.620 Meters 305 - 7620 Millimeters

Low Distance Simulation sets the low distance point for simulation. (See Figure 4.31)

Menu	Parameter	Options
Utilities	<i>High Distance Simulation</i>	Default = 1.00 (ft) 1.00 - 25.00 Feet 12.0 - 300.0 Inches 0.305 - 7.620 Meters 305 - 7620 Millimeters

High Distance Simulation sets the high distance point for simulation. (See Figure 4.31)

Menu	Parameter	Options
Utilities	<i>Simulation Cycle Time</i>	Default = Off 0 -9 seconds = Off 15 - 9999 seconds = On

Simulation Cycle Time sets the running time for a cycle simulation between the low distance point and high distance point set above. (See Figure 4.31)

Menu	Parameter	Options
Utilities	<i>Reset</i>	Default = No Reset No Reset Sensor Reset

Reset resets the sensor to factory defaults. (See Figure 4.31)

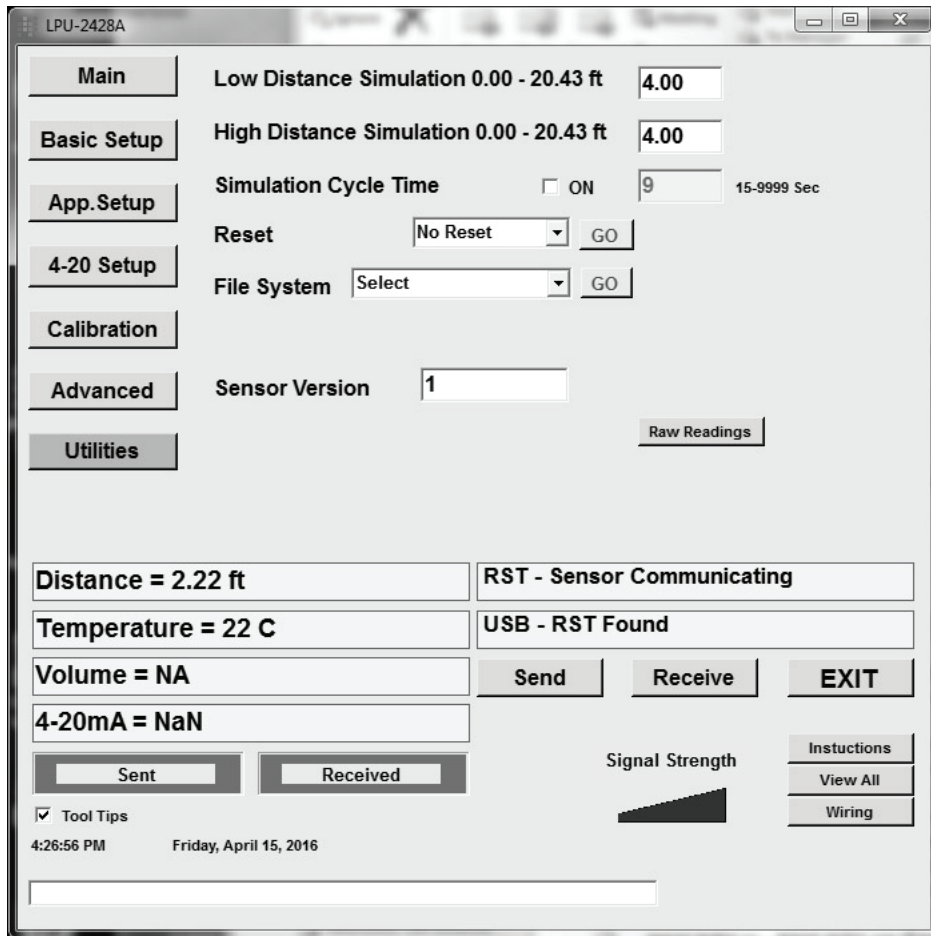

Figure 4.31

Menu	Parameter	Options
Utilities	<i>File System</i>	Default = None Sensor to File File to Sensor Compare Sensor to File None

File System allows the user to edit, save, and load text files containing sensor parameters. (See Figure 4.31)

Menu	Parameter	Options
Utilities	<i>Sensor Version</i>	

Sensor Version displays the current software version running on the sensor. (See Figure 4.31)

Menu	Button	Options
Utilities	<i>Raw Readings</i>	

Clicking the *Raw Readings* button displays the raw readings from the sensor. (See Figure 4.31a)

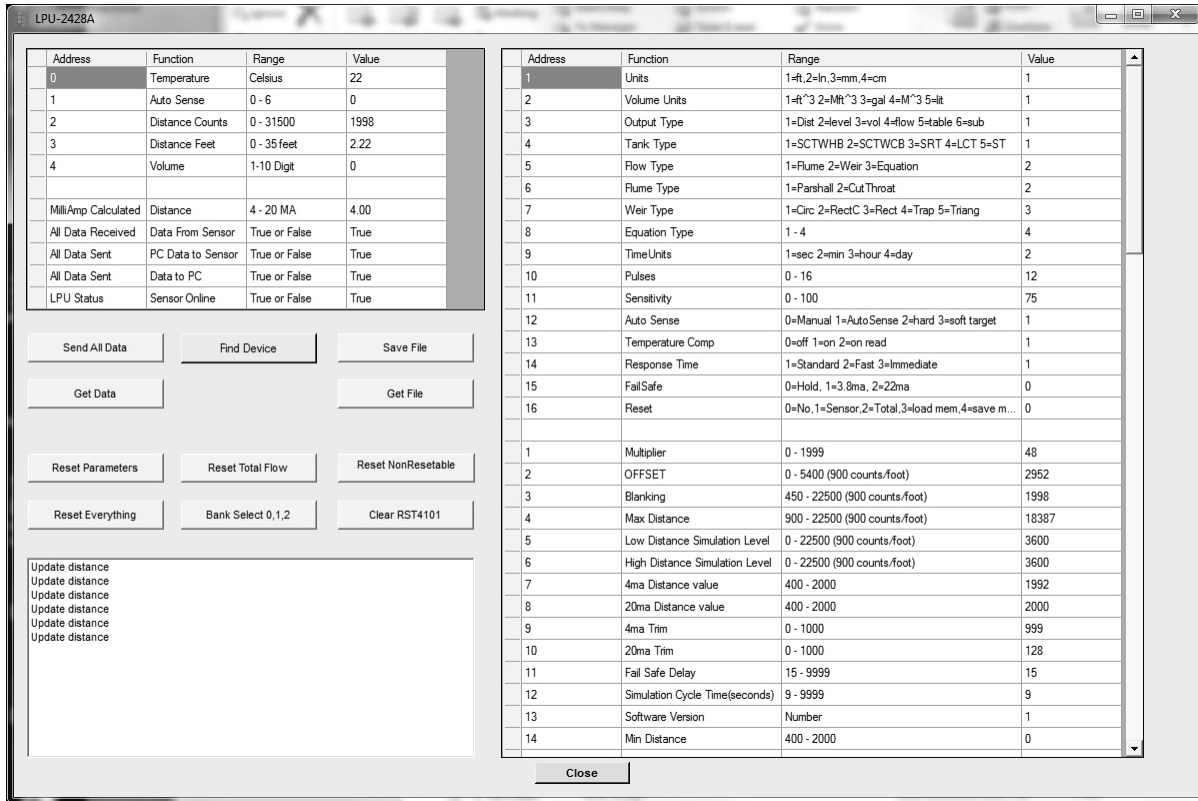

Figure 4.31a

All of the information and options on this screen are for advanced users only. Everything necessary to operate the LPU-2428 and the LPU-2428A Software is available through the regular menus.

- **Totalization Menu**

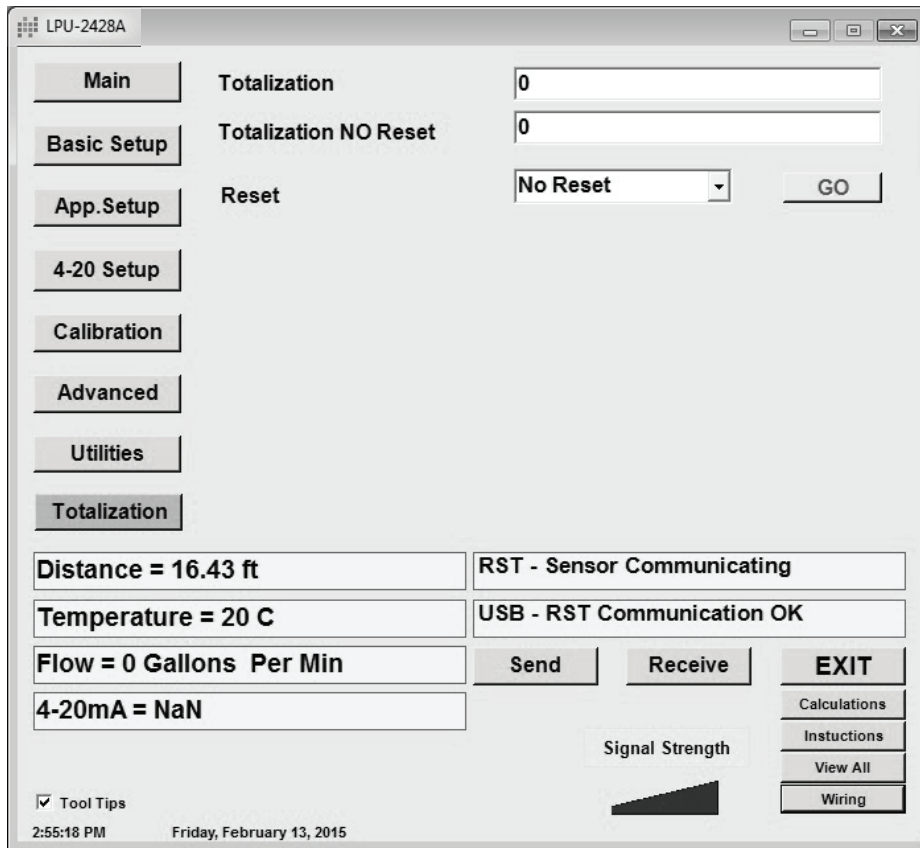

Figure 4.32

App Function	Parameter	Options
Flow	<i>Totalization</i>	Totalization Totalization NO Reset Reset

Totalization is a submenu available only when Flow is the selected Application/OutFunc. The sensor writes to two totalizers--one of which can be reset--and updates the totals to the LPU-2428A software in one minute increments. (See Figure 4.32)

Chapter 5: Hazardous Location Drawings and Certification

- Intrinsically Safe Wiring Diagram

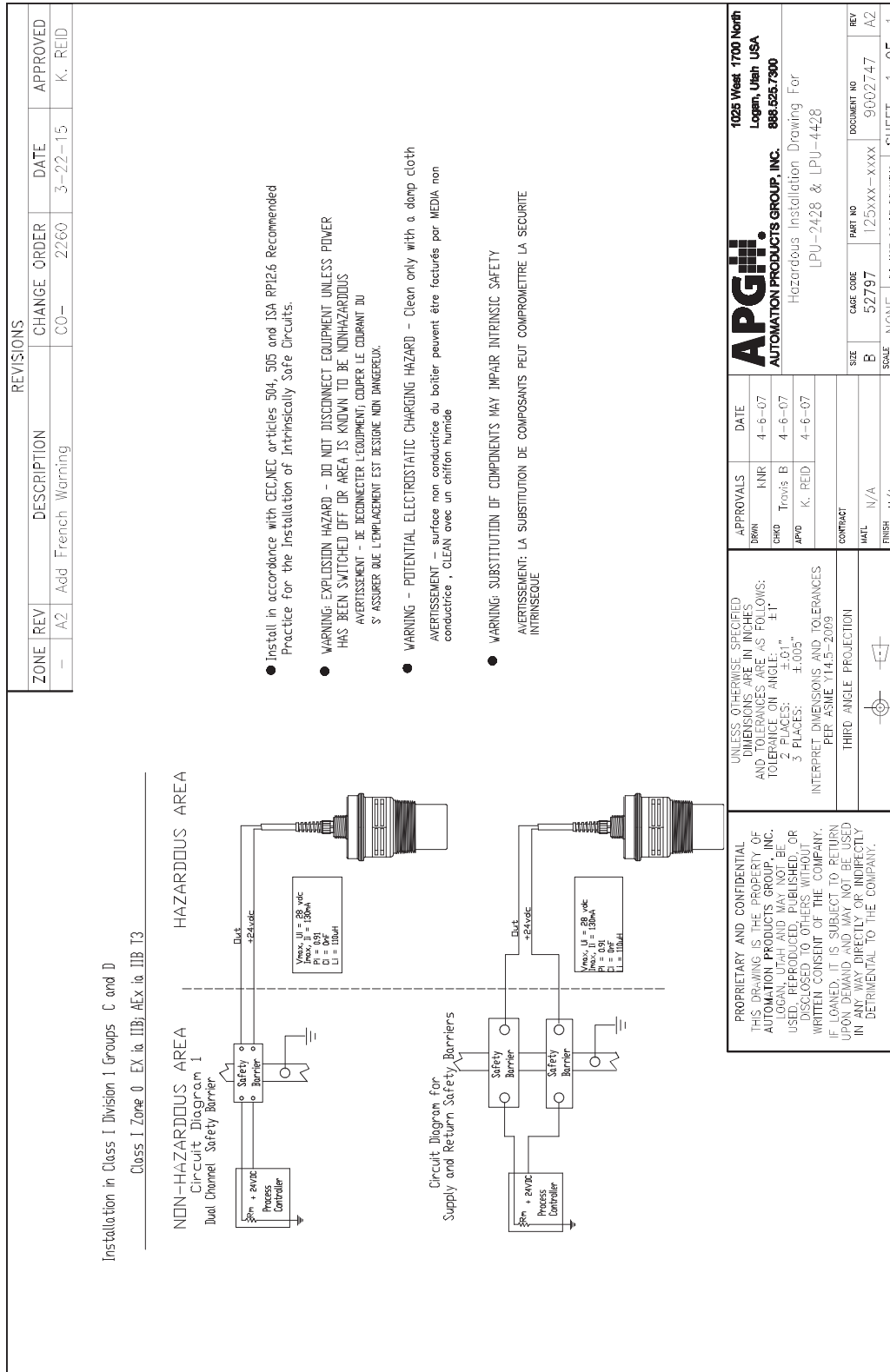

Hazardous Location Wiring Diagram

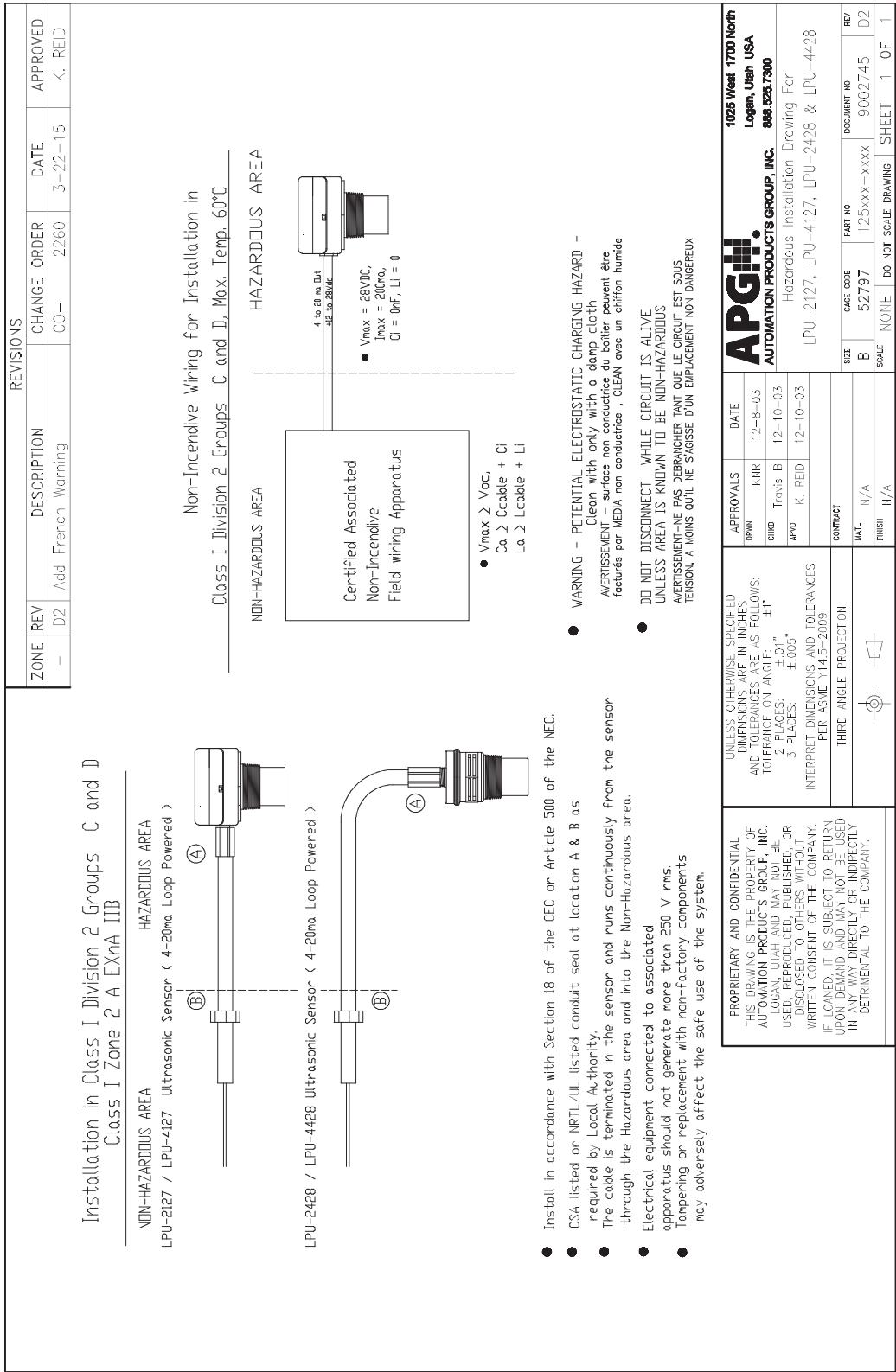

• **CSA Certificate of Compliance**



Certificate of Compliance

Certificate: 1911747

Master Contract: 237484

Project: 2386064

Date Issued: April 29, 2011

Issued to: Automation Products Group Inc

1025 West 1700 North
Logan, UT 84321
USA
Attention: Karl Reid

The products listed below are eligible to bear the CSA Mark shown with adjacent indicators 'C' and 'US' for Canada and US or with adjacent indicator 'US' for US only or without either indicator for Canada only.



Rawn Murphy

Issued by: Rawn Murphy

PRODUCTS

CLASS 2258 82 - PROCESS CONTROL EQUIPMENT - For Hazardous Locations -
Certified to US Standards

CLASS 2258 02 - PROCESS CONTROL EQUIPMENT - For Hazardous Locations

Class I, Division 2, Groups C and D, T6

Ex nA IIB T6; IP65

Class I, Zone 2; AEx nA IIB T6; IP65

LPU Series Ultrasonic Sensors, Models LPU-2127, LPU-4127, LPU-2428 and LPU 4428; Rated input 12 to 28Vdc, Outputs 4-20mA; Ambient temperature range -40°C to +60°C.

LOE Series Ultrasonic Sensors, Models LOE-2126, LOE-6126, and LOE-3136; Rated input 48VDC or 12 to 28Vdc, 200 mA containing two optically-coupled MOSFET solid-state relay outputs rated 1500 Vr.m.s isolation voltage; Ambient temperature range -40°C to +60°C.

Note:

1) The LOE Series shall be powered by a suitable certified Class 2 power supply.



Certificate: 1911747

Master Contract: 237484

Project: 2386064

Date Issued: April 29, 2011

CLASS 2258 04 - PROCESS CONTROL EQUIPMENT - Intrinsically Safe, Entity - For Hazardous Locations

CLASS 2258 84 - PROCESS CONTROL EQUIPMENT - Intrinsically Safe, Entity - For Hazardous Locations - Certified to US Standards

Class I, Division 1, Groups C and D, T3

Ex ia IIB, T3 (Canada); IP65

Class I, Zone 0; AEx ia IIB, T3 (USA); IP65

LPU-2428 and LPU-4428 ultrasonic sensors; Rated input 12 to 28VDC, Outputs 4-20mA, Ambient temperature range -40°C to +60°C. Entity Parameters Vmax = 28VDC, Imax = 130mA, Pi. 0.91W, Ci = 0nF, Li = 110µH, intrinsically safe when connected in accordance with Installation drawing 9002747.

APPLICABLE REQUIREMENTS

CAN/CSA Standard C22.2 No. 0-M91	General Requirements - Canadian Electrical Code, Part II
CSA Standard C22.2 No.142-M1987	Process Control Equipment Industrial Products
CAN/CSA Standard C22.2 No.157-92	Intrinsically Safe and Non-Incendive Equipment for Use in Hazardous Locations
CAN/CSA Standard C22.2 No.213-M1987	Non-incendive Electrical Equipment for Use in Class I, Division 2 Hazardous Locations Industrial Products
CAN/CSA Standard E60079-0-02	Electrical Apparatus for Explosive Gas Atmospheres – Part 0: General Requirements
CAN/CSA Standard E60079-11-02	Electrical Apparatus for Explosive Gas Atmospheres – Part 11: Intrinsic Safety "i"
CAN/CSA Standard E60079-15-02	Electrical Apparatus for Explosive Gas Atmospheres - Part 15: Type of Protection "n"
CAN/CSA Standard C22.2 No. 60529-05	Degrees of Protection Provided by Enclosures (IP Code)
UL Standard 508	Industrial Control Equipment
UL Standard 913	Intrinsically Safe Apparatus and Associated Apparatus for Use in Class I, II, and III, Division 1, Hazardous (Classified) Locations



Certificate: 1911747

Master Contract: 237484

Project: 2386064

Date Issued: April 29, 2011

ANSI/ISA Standard 12.12.01-2007	Nonincendive Electrical Equipment for Use in Class I and II, Division 2, and Class III Divisions 1 and 2 Hazardous (Classified) Locations
UL Standard 60079-0	Electrical Apparatus for Explosive Gas Atmospheres – Part 0: General Requirements
UL Standard 60079-11	Electrical Apparatus for Explosive Gas Atmospheres Part 11: Intrinsic Safety "i"
UL Standard 60079-15	Electrical Apparatus for Explosive Gas Atmospheres Part 15: Electrical Apparatus with Type of Protection "n"
IEC 60529	Degrees of Protection Provided by Enclosures (IP Code)

MARKINGS

The following markings are provided on CSA-Accepted (Class 7922-01, File number 99316) adhesive label stock Product Number 7871 manufactured by 3M Company, which is suitable for indoor or outdoor use on Plastic Group VII, at a maximum service temperature of 80°C or higher. The label stock shall be printed with one of the approved printer and ink combinations as specified in the manufacturers listing and the finished label is affixed to the housing.

- Manufacturer’s name, “Automation Products Group”, or CSA Master Contract Number “237484”, adjacent to the CSA Mark in lieu of Manufacturer’s name.
- Model number: as specified in the PRODUCTS section, above.
- Electrical ratings: as specified in the PRODUCTS section, above.
- Ambient temperature rating: as specified in the PRODUCTS section, above (may be abbreviated).
- Manufacturing date in MMYYY format, or serial number, traceable to month of manufacture.
- The CSA Mark with “C” and “US” indicators, as shown on the Certificate of Conformity.
- Hazardous Location designation: as specified in the PRODUCTS section, above.
- Temperature Code: as specified in the PRODUCTS section, above (May appear on control drawing).
- Class I Division 1 additional Markings -
 - “Exia” followed by “IIB”
 - “INTRINSICALLY SAFE”
 - “WARNING– EXPLOSION HAZARD – SUBSTITUTION OF COMPONENTS MAY IMPAIR INTRINSIC SAFETY” (Equivalent wording is acceptable).
 - “WARNING– TO PREVENT IGNITION OF FLAMMABLE OR COMBUSTIBLE ATMOSPHERES, DISCONNECT POWER BEFORE SERVICING”.
 - “Install per Drawing 9002748” (or equivalent): as specified in the PRODUCTS section, above
- Class I Division 2 additional Markings –
 - “Ex nA” followed by “IIB”
 - “WARNING– DO NOT DISCONNECT EQUIPMENT UNLESS AREA IS KNOWN TO BE NON-HAZARDOUS”.
 - “WARNING – POTENTIAL ELECTROSTATIC CHARGING HAZARD – SEE INSTRUCTIONS” (or equivalent).



Certificate: 1911747

Master Contract: 237484

Project: 2386064

Date Issued: April 29, 2011

-
- For the LPU Series Ultrasonic Sensors, the words “Reference installation drawing number 9002745” (or equivalent): as specified in the PRODUCTS section, above
 - For the LOE Series Ultrasonic Sensors, the words “Reference installation drawing number 9003469” (or equivalent): as specified in the PRODUCTS section, above
 - For the LOE Series Ultrasonic Sensors, the manual shall contain the following words: “WARNING – NONCONDUCTIVE SURFACE OF THE HOUSING MAY BE CHARGED BY NONCONDUCTIVE MEDIA, CLEAN WITH A DAMP CLOTH”

Note - Jurisdictions in Canada may require these markings to also be provided in French language. It is the responsibility of the manufacturer to provide bilingual marking, where applicable, in accordance with the requirements of the Provincial Regulatory Authorities. It is the responsibility of the manufacturer to determine this requirement and have bilingual wording added to the "Markings".



Automation Products Group, Inc.

Tel: 1/888/525-7300 • Fax: 1/435/753-7490 • www.apgsensors.com • sales@apgsensors.com